



# HT Series Scale System Operator Manual

ML-29350	HTi-7LS
ML-29351	HTi-LS
ML-29352	HTiP-LS
ML-29354	HTi-7ELS
ML-29380	HTi-7LS2
ML-29381	HTi-LS2
ML-29382	HTiP-LS2
ML-29384	HTi-7ELS2
ML-29367	HTi-10ELS
ML-29377	HTi-10ELS2
ML-29369	HTi-7LH
ML-29370	HTi-LH
ML-29371	HTiP-LH
ML-29372	HTi-7ELH
ML-29368	HTi-10ELH
ML-29359	HTs-LS
ML-29360	HTsP-LS
ML-29361	HTs-7LS
ML-29362	HTs-7ELS
ML-29363	HTs-LST
ML-29364	HTsP-LST
ML-29365	HTs-7LST
ML-29366	HTs-7ELST
ML-29373	HTi-SSLS
ML-29374	HTi-SSLSB
ML-29428	HTM-LH
ML-29429	HTM-7LH
ML-29330	HTM-7ELH
ML-29431	HTM-SSLS
ML-29432	HTM-SSLSB

**HOBART**

701 S. RIDGE AVENUE  
TROY, OHIO 45374  
[www.hobartcorp.com](http://www.hobartcorp.com)



Chapter 1: Introduction. . . . . 1-1

    Welcome. . . . . 1-1

    FCC Note . . . . . 1-1

    Industry Canada Note . . . . . 1-1

    Verify Correctness of Weight and Price. . . . . 1-2

    Operator Manual Terminology. . . . . 1-2

Chapter 2: Understanding the System . . . . . 2-1

    Electrical Connections . . . . . 2-1

    Communication Connections . . . . . 2-1

    Operator Screens Overview . . . . . 2-2

    Scale Operation Mode Setup . . . . . 2-6

    Menu Icon Features . . . . . 2-9

    Keypad and Keyboard Icons. . . . . 2-11

Chapter 3: Using the HT Scale System . . . . . 3-1

    Power Up the System . . . . . 3-1

    Reboot Button. . . . . 3-1

    Logging onto the System . . . . . 3-2

    Hands Free Login . . . . . 3-2

    Shutting Down the System . . . . . 3-3

    Center Operator Screen . . . . . 3-4

    Right Operator Screen . . . . . 3-5

    Modifying the Operator Screens. . . . . 3-6

    Running a Product . . . . . 3-10

    Using Create COOL . . . . . 3-12

    Modifying the Printer Settings . . . . . 3-13

    Viewing Expiration Label History . . . . . 3-14

    Selecting Total Types . . . . . 3-15

    Voiding a Transaction . . . . . 3-15

    Rezero the Weigher . . . . . 3-16

    Using the Search Function . . . . . 3-18

    Viewing Product Notes. . . . . 3-19

    Viewing Operator Note . . . . . 3-20

    Viewing Weights & Measures Information . . . . . 3-21

    Viewing About Scale Information . . . . . 3-22

    Help . . . . . 3-23

    Using Now Serving Tickets . . . . . 3-24

    Using the Flashkey Editor . . . . . 3-24

    HTi Self-Service Scale . . . . . 3-26

    Using Self Service Mode . . . . . 3-27

    Leaving Self Service Mode . . . . . 3-34

    Using Meal Planner . . . . . 3-37

    Using Pick 5 . . . . . 3-38

    Multi Department . . . . . 3-40

    Cutting Test . . . . . 3-41

Selecting Label Stock Type .....	3-43
Chapter 4: Maintenance & Cleaning .....	4-1
Removing the Label Cassette .....	4-1
Installing the Label Cassette .....	4-1
Removing the Label Roll .....	4-2
Loading the Label Roll .....	4-3
Removing the Auto-Cutter Label Cassette (for Linerless Labels) .....	4-3
Installing the Auto-Cutter Label Cassette (for Linerless Labels) .....	4-4
Removing the Label Roll from Auto-Cutter Cassette (for Linerless Labels) .....	4-5
Loading the Linerless Label Roll into Auto-Cutter Cassette .....	4-6
Removing the Scale Platter .....	4-7
Replacing the Scale Platter .....	4-7
Adjusting Console Position .....	4-8
Leveling the Scale .....	4-9
Checking Printhead Dot Status .....	4-11
Cleaning the Printhead .....	4-12
Cleaning the Exterior of Scale .....	4-13
Troubleshooting .....	4-13
Chapter 5: Hands Free Login .....	5-1
Hands-Free Pager Device Hardware .....	5-1
HFPD Display .....	5-1
HFPD Button .....	5-3
HFPD Speaker .....	5-3
Device Operation .....	5-3
Device Configuration .....	5-3
Associating with Operators .....	5-3
Hands Free Login App .....	5-5
Configuring Hands-Free Pager Device .....	5-6
Configuring HFPD Fields and Settings .....	5-7
Messages .....	5-10
Firmware .....	5-10
Add Firmware to Scale .....	5-11
Uploading Firmware .....	5-12
Alert Configuration .....	5-13
Index: .....	I-1



---

# Chapter 1: Introduction

---

## Introduction

---

### Welcome

---

The HT Series Scale System is perfect for your over-the-counter weighing applications. This weighing system can handle a broad variety of products for deli, produce, seafood, cheese, and meat departments. It enhances your merchandising capabilities with multiple fonts, graphics, and label types.



### HT Series Scale System

All necessary operator data appears on the touch screen.

---

### FCC Note

---

This equipment has been tested and found to comply with the limits for a Class A digital device, pursuant to Part 15 of the FCC rules. These limits are designed to provide reasonable protection against harmful interference when the equipment is operated in a commercial environment. This equipment generates, uses and can radiate radio frequency energy and, if not installed and used in accordance with the instruction manual, may cause harmful interference to radio communications. Operation of this equipment in a residential area is likely to cause harmful interference, in which case, the user will be required to correct the interference at their own expense.

---

### Industry Canada Note

---

The term “IC:” before the equipment certification number signifies that the Industry Canada Technical Specifications were met.

---

## Verify Correctness of Weight and Price

---

Routinely verify label information. Check the multiplication of price per pound times weight, and check the scale weight against printed label weight. Weigh the same package several times to verify outcome consistency. Packages that weigh near the middle of the 0.005 lb. increment will vary up or down by 0.005 lb. Variation greater than 0.005 lb indicates the need for weigher adjustment. In such a case, or whenever necessary, contact your local Hobart Representative.

---

## Operator Manual Terminology

---

This manual uses the following terminology for keystrokes and data manipulation procedures:

- The word TYPE means to touch a series of keys on the Numeric Keypad or QWERTY Keyboard.
- The word TOUCH means to activate an entry shown on the display screen.
- The word SELECT means to choose one item from a list brought up on the current screen.
- The word SWIPE means to touch the screen or the area below the screen and drag in a direction.

The following special instructions are used in the manual:

**NOTE:** A **Note** is information that you need to know, but is not an actual step in the process.

### **NOTICE**

A **NOTICE** is information to alert you that you may be doing something that will permanently alter your system.

### **⚠ WARNING**

A **WARNING** indicates a hazardous situation which, if not avoided, could result in serious injury or death.

## Chapter 2: Understanding the System

### Understanding the System

The HT Scale System can store information on thousands of products. Retail store information required for product handling and processing, such as PLU number, UPC number, Pricing, Tare, and Shelf Life can be added. Consumer information describing products, such as NutriFacts, Safe Handling, Expanded Text, Health Tips, Meal Planners, Recipes, Cooking Instructions, and Merchandising Graphics can also be added.

**NOTICE**

The scale should be installed and/or moved only by a qualified Hobart Service Technician. The system can operate in a temperature range from 14°F to 104°F (-10°C to 40°C).

### Electrical Connections

A power cord is provided and connects to the bottom of the scale. Electric power of 120 V., 60 Hz., 1 phase (2-wire plus ground) is required.

### Communication Connections

There are several ports that are available.

- Two Type A USB 2.0 Ports
- RJ-45 Jack for an Ethernet Connector (TCP/IP)
- Audio Jack for external headphones

**NOTE:** When Audio Jack is in use the scale speakers will be muted.

**NOTE:** The HTs models only have one USB port.

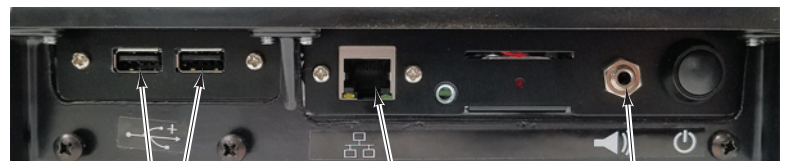

TYPE A  
USB 2.0 PORTS

RJ-45 JACK

3.5mm  
AUDIO JACK

## Operator Screens Overview





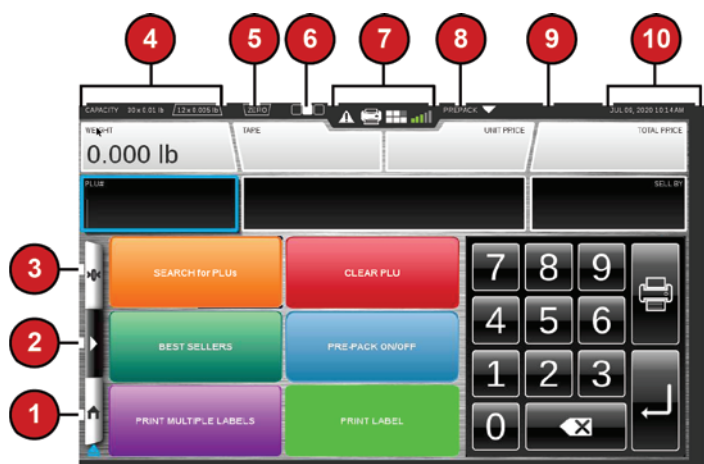

The Operator Screens are touch screens that enable you to enter information and move through the scale features. There are three screens as indicated by the Screen View Location icon. TOUCH the left square of the icon to move to the left or the right square to move to the right. You can also TOUCH and SWIPE left to right to move to the left screen or TOUCH and SWIPE right to left to move to the right screen.

The following items will appear on all three screens in the same location. See the *Fixed Features on the Operator Screen* table for detailed information about each feature. The center screen is shown.

1. Home Icon
2. Menu Icon
3. Rezero Icon
4. Capacity Information
5. Zero Indicator
6. Screen View Location
7. Alert Section
8. Scale Operation Mode
9. Operator Name, if operator login required
10. Date and Time

**NOTE:** The location of the information bar across the top can be configured to display across the bottom of the screen. The Menu icon and Home icon can be configured to display on the right side of the screen. These modifications can be made in Supervisor mode.



Fixed Features on the Operator Screen		
No.	Feature	Description
1.	Home Icon	This icon will return you to the main page. The main page can either be the left or center screen. The HTs models will not use the left screen unless equipped with the browser function. This is configured in supervisor mode. If the Home Icon has a small square with an arrow in it, that means that a multimedia file is 
2.	Menu Icon	This icon is the access point to additional scale features. See <a href="#">Menu Icon Features</a> for more information.
3.	Rezero Icon	This icon is used to zero the weigher without anything on the platter.
4.	Capacity Information	This area shows the scale capacity. Current capacity range is shown within a trapezoid.
5.	Zero Indicator	This icon appears when no weight is on the scale and the scale is zeroed.
6.	Screen View Location	This icon shows which of the three screens is displayed. A solid square indicates the current screen. The HTs models will not use the left screen unless equipped with the browser function.
7.	Alert Section	This section displays four different alerts.
	User Alert 	This icon will flash red when a message is available. TOUCH the icon to display the message. The icon will remain white when there are no active user alerts.
	Printer Alert 	This icon will flash red when there is a printer issue such as the label cassette is open or the printer is out of labels. TOUCH the icon to display the message. The icon will remain white when no message exists.
	Planogram 	This icon will flash red when a planogram message is available. TOUCH the icon to display the message. The icon will remain white after the planogram has been viewed.
	Network Connectivity	 r strength  for a wireless connection. If connectivity is lost, the background of the scale application will be red (if enabled) and the icon will be red and flashing. TOUCH to view network details if enabled.
8.	Scale Operation Mode	This selection is used to determine how the scale will be used. See <a href="#">Scale Operation Mode Setup</a> for more information.
9.	Operator Name	This area shows the operator name, if login is required.
10.	Date and Time	This area shows the current date and time. This information is provided by the operating system.

The left Operator Screen contains the Fixed Features and an area for dynamic content. The dynamic content area can be configured by the scale supervisor. See [Using the Flashkey Editor](#) for more information about dynamic content areas.

**NOTE:** The HTs models will not use the left screen unless equipped with the browser function or a full screen flashkey license.

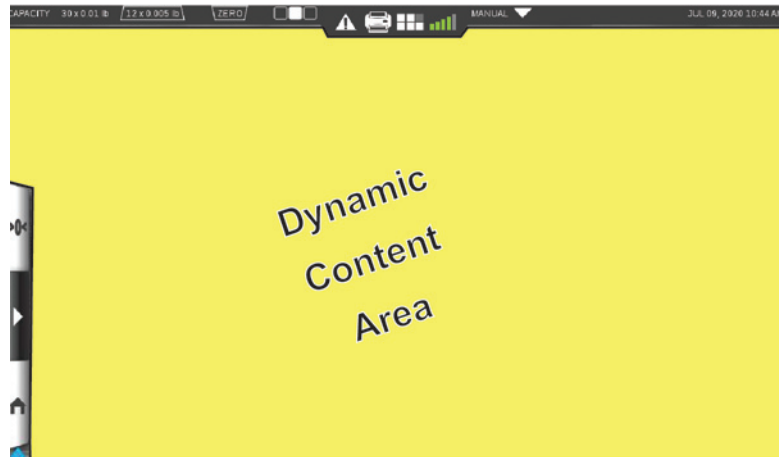

The center Operator Screen contains the Fixed Features, a numeric keypad if configured, product information, and an area for dynamic content. Some information fields such as COOL, Best Before, and Packed On can be turned off by the scale supervisor. The dynamic content area and numerical keypad can be configured by the scale supervisor. See [Using the Flashkey Editor](#) for more information about dynamic content areas.

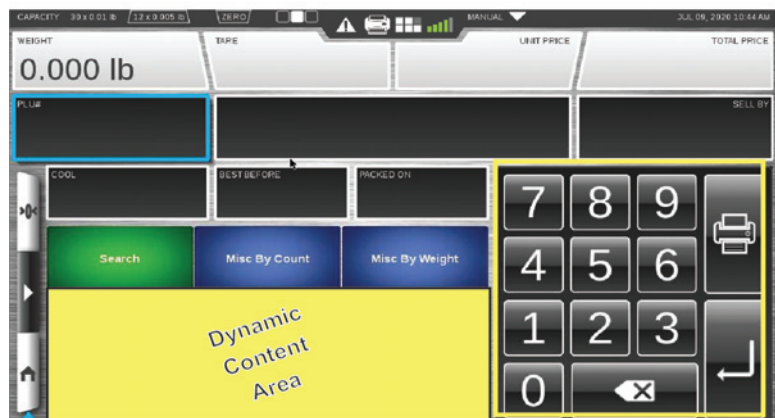

Center Operating Screen

The right Operator Screen contains the Fixed Features, additional product information, and label information.



**Right Operator Screen**

## Scale Operation Mode Setup

The HT Scale System can be configured to be used in different ways according to the needs of your operation. The Scale Operation Mode feature will allow the scale to be set up to operate in Self Serve, Manual, Prepack, Production Entry, or Accumulate Items mode if configured in Supervisor mode.

TOUCH the Scale Operation Mode area. You should now see the *Scale Operation Mode Setup Screen*.



**NOTE:** Once you touch a selection on this screen, the item is selected and the screen closes.

To Set Scale in Self Service Mode: TOUCH the Self Service Operator selection. The Scale will start in Self Serve mode. See [Using Self Service Mode](#) for details about using this mode.

To Set Scale in Manual Mode: TOUCH the Manual Operation selection. A black dot will appear in the circle and the word MANUAL will display in the Scale Operation Mode area.

To Set Scale in Prepack Mode: TOUCH the Prepack Operation selection. A black dot will appear in the circle and the word PREPACK will display in the Scale Operation Mode area.

To Set the Item Entry Type: TOUCH the desired feature; Normal, Accumulate Items, and Production Entry. A blue highlight around the box indicates the feature is selected.

The Manual Mode is designed for single transactions, typically found in most deli counter operations. The user will place the product on the scale, enter a PLU, and TOUCH the print icon to print the label.



The Prepack Mode is designed for multiple transactions, typically found in meat rooms. The user will place the product on the scale and enter a PLU. When the weight is stable, the label will print. You do not need to TOUCH the print icon to print the label. After the label prints, the scale will NOT clear the product information. The user can place another package with the same PLU on the scale and print another label.

The Item Entry Type can be Normal, Accumulate Items, or Production Entry.

**NOTE:** The Accumulate Items and Production Entry only use Manual Mode.

The Production Entry mode enables you to enter several fixed weight or by count PLU's and the number of labels you want to print for each. For example, Production Entry allows you to print 100 bread labels and 50 cupcake labels with one operation.

**NOTE:** When using production entry you may want to set up your scale to stream labels (print labels without removing the backing paper from the label).

The Accumulate Items feature is used in some bakery or other operations where multiple PLU's are sold in one transaction. The Accumulate Items mode enables you to print one label or a series of labels for multiple PLUs. The scale can be configured to print either Item Total Labels or Itemized Receipts. When configured, you can print a label for each product and/or an Item Total Label for all products. The Item Total Label contains only the grand total and barcode. Refer to the following examples:





**Menu Icon Features**

The Menu Icon provides the user access to various features of the





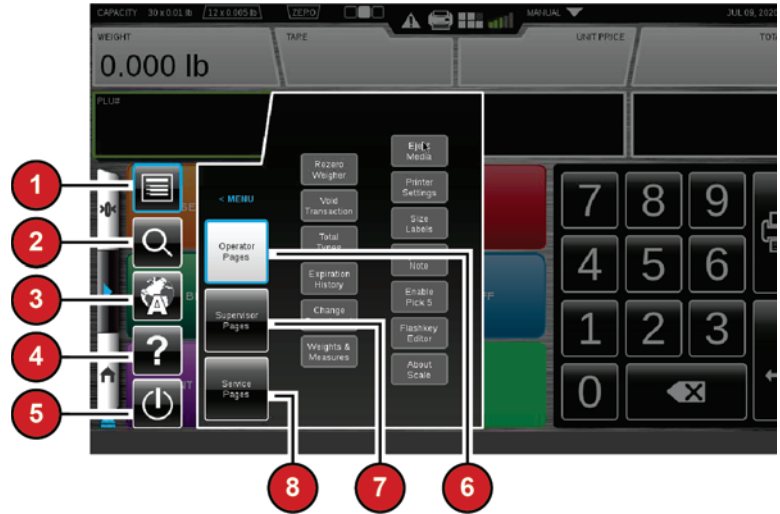





*Menu Window.*



The following items will appear on the Menu Window. See the Menu Icon Features table for detailed information about each feature.





1. Menu
2. Search
3. Language Toggle
4. Help
5. Shutdown Icon
6. Operator Pages
7. Supervisor Pages
8. Service Pages

A blue highlight around the box indicates the feature is selected.

Menu Icon Features			
No.	Feature	Icon	Description
			or Service Pages.
			key word. See <i>Using the Search Function</i> for more detailed information.
3.	Language Toggle		TOUCH this icon to toggle between the available languages on the scale. Scales can be configured to toggle between English/Spanish or English/French. If you have questions about this feature, contact your local Hobart Representative.
			g videos.
			ting system. See <i>Shutting Down the System</i> for more information.
			ions.
7.	Supervisor Pages		TOUCH this box to access supervisor level functions. Detailed information about the Supervisor level functions can be found in the HT Series Scale System Supervisor Manual.
			art Service Representatives.

**Keypad and Keyboard Icons**

Use the following chart to identify icons that appear on the keypad or keyboard. The Keypad is the numerical pad. The Keyboard is the alpha-numeric pad visible when using any text entry field.

Menu Icon Features		
Feature	Icon	Description
		
Enter		TOUCH this icon to accept information.
Delete		TOUCH this icon to delete entered information. One touch will delete one character. If you touch and hold, it will delete all characters.
Keyboard Close		TOUCH this icon to close the QWERTY keyboard.



## Chapter 3: Using the HT Scale System

---

### Using the HT Scale System

---

The instructions for using the HT Scale System are detailed in this chapter.

---

### Power Up the System

---

To power up the HT Scale System, plug the power cord into a 120 VAC dedicated electrical receptacle.

---

### Reboot Button

---

Located on the left side of the scale is the Reboot Button.

**NOTE:** HTi model shown. The HTs models only have one USB port.



**REBOOT  
BUTTON**

Press the Reboot Button. A screen will appear and say, “Scale is rebooting please do not remove power.”

In the unlikely event the scale stops responding, use the Reboot Button to reboot the scale.

**NOTICE**

Pressing the Reboot Button should only be used when the scale has stopped responding.

---

## Logging onto the System

---

The HT Scale System may require an operator to login before printing a label. Not all systems are set up to require an operator to login.

**NOTE:** The Operator Login Screen can be configured to show a popup keypad or a full keyboard.

If required to login: TYPE the Operator ID and TOUCH OK.

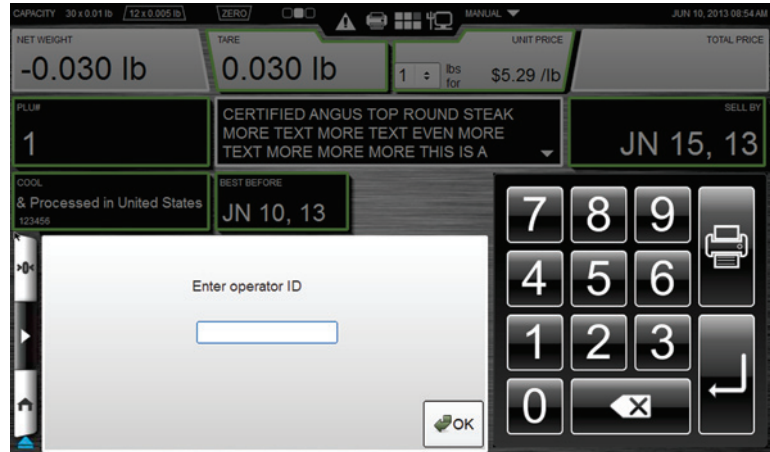

---

## Hands Free Login

---

For Hands Free login in Devices. Operator must turn on device. When the device is in range, the scale will automatically log the operator in.



**NOTE:** For further instructions on using Hands Free Login, see Chapter 5 - [Hands Free Login](#).



## Shutting Down the System

The Shutdown feature is designed to stop all internal functions. Shutdown is required before power can be disconnected from the system.

To Shutdown the System:



3. Screen will appear and ask “Are you sure you want to shutdown?”

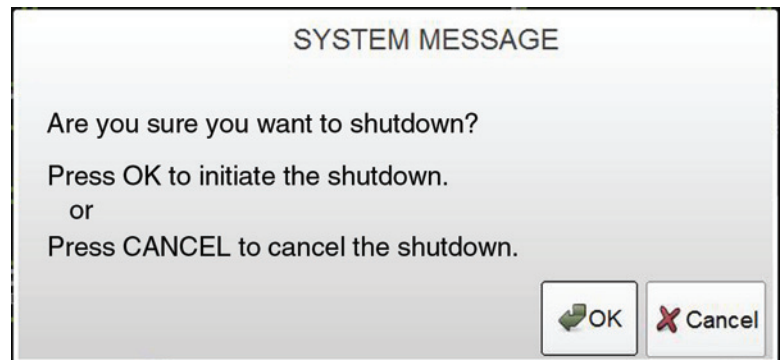

4. TOUCH OK.
5. When the system is ready to shutdown, a screen will appear and say, “The scale application is ready to shutdown. Press the Shutdown button to power down the scale or Reboot to restart.” TOUCH Shutdown.

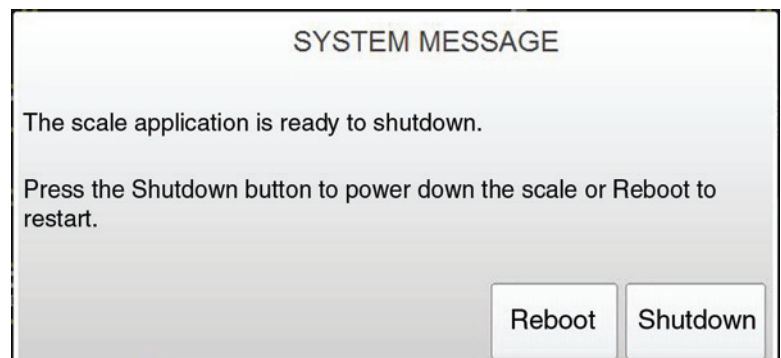

### **NOTICE**

**DO NOT** disconnect power to the system during shutdown.

6. Wait for the scale system to shutdown (the screen will go black).
7. Unplug scale to remove power.

## Center Operator Screen

The Center Operator Screen displays product information for the PLU that is entered. The type of data displayed depends upon the product weigh type of the PLU.

The Center Operator Screen displays the following information, if applicable:

1. Weight
2. Tare
3. Unit Price
4. Total Price
5. PLU Number
6. Description
7. Sell by date
8. Country of Origin Label (COOL) Text & Tracking Number (optional)
9. Best before date (optional)
10. Packed on date (optional)
11. By Count (not shown, will display instead of the Unit Price field if the PLU is sold by count or by fixed weight)
12. Net Weight (not shown, will display instead of the Weight and/or Tare fields if the PLU is sold by fixed weight)

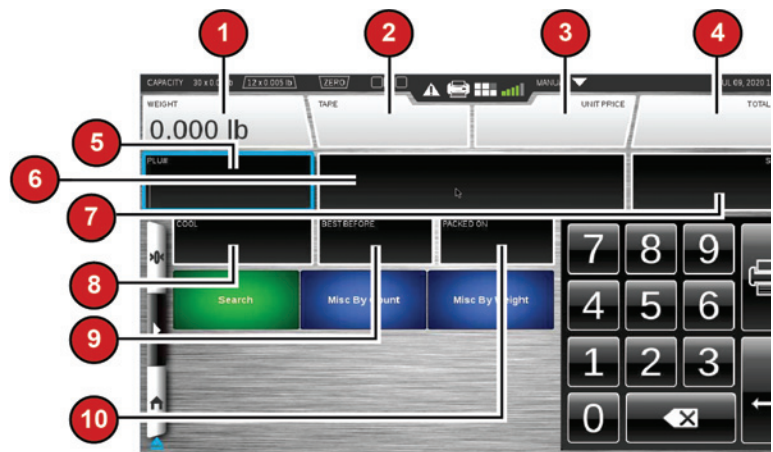

**NOTE:** System configuration may show different options.

## Right Operator Screen

The Right Operator Screen displays product and label information for the PLU that is entered. The type of data displayed depends upon the data loaded for the PLU.

The Right Operator Screen displays the following information, if applicable:

1. UPC Number
2. Discount Unit Price
3. Discount Total Price
4. Savings
5. Shelf Life (Hours)
6. Product Life (Hours)
7. Label Stock
8. Primary Label ID
9. Primary Graphic ID
10. Additional Label IDs
11. Additional Graphic IDs
12. Nutrition Facts Panel
13. Expanded Text
14. Recipe
15. Cooking Instructions
16. Allergens

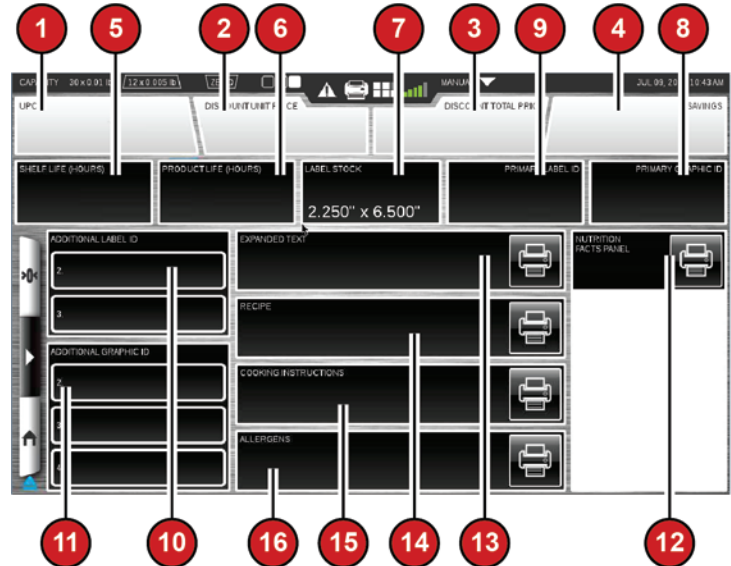

**NOTE:** System configuration may show different options.

## Modifying the Operator Screens

The operator can modify certain settings, if configured in the Supervisor mode, that display on the Operator Screens once a PLU is entered. Only text fields with a green highlight around the box can be modified. Text fields with a blue highlight indicate the field is active and input from the keypad will modify the contents of the field. Text fields with a white border cannot be edited and provide information only.

**NOTE:** Changes made on the Operator Screens, other than certain COOL information, will be in effect for the current run only. The scale will revert to the system default settings when a different PLU is entered.



**NOTE:** These fields can only be changed in Operate Mode if you have the proper permissions.

To change Field values: TOUCH the field and TYPE the change on the Keypad. TOUCH Enter. The value change will be displayed in the field. This applies to Unit Price, PLU#, and By Count on the Center Operator Screen. This applies to Shelf Life (Hours), Product Life (Hours), Primary Label, and Additional Labels IDs on the Right Operator Screen.

To change Tare field: TOUCH the Tare field. TYPE the tare on the keypad or TOUCH the desired value from the tare grid as shown.

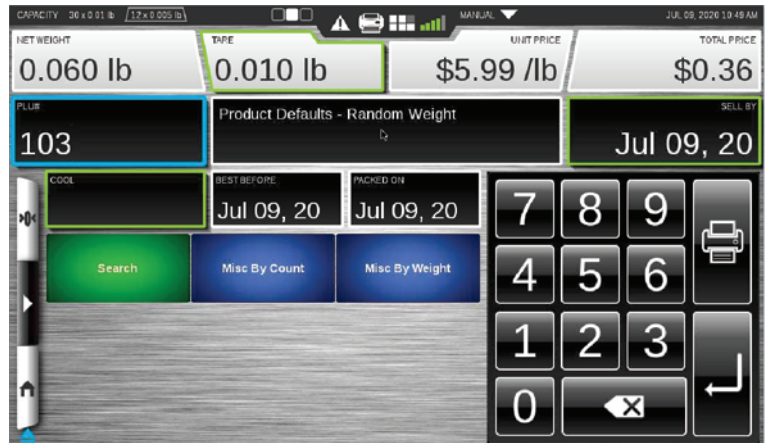

**NOTE:** The Tare Grid, shown above in the dynamic content area, is a feature that can be configured by the supervisor or operator.

**NOTE:** Tare entry precision is based on scale division size.

To change COOL: TOUCH the COOL field. You should now see the **COOL Window**.

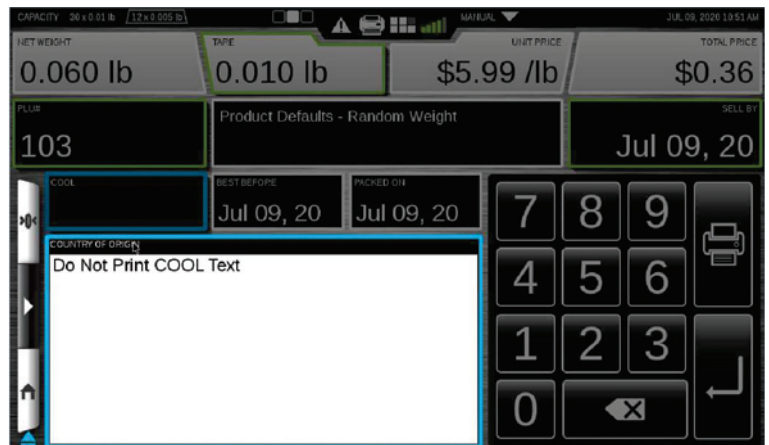

**NOTE:** See Using Create COOL for information about modifying COOL. The setting changes made will be displayed on the Operator Screens.

SELECT the COOL text from the list available. TOUCH Done.

**NOTE:** “No COOL Text” means Do Not Print COOL on the label.

To change the Sell By date or Best Before date: TOUCH the Sell By or Best Before field to activate. You should now see the Calendar Window.

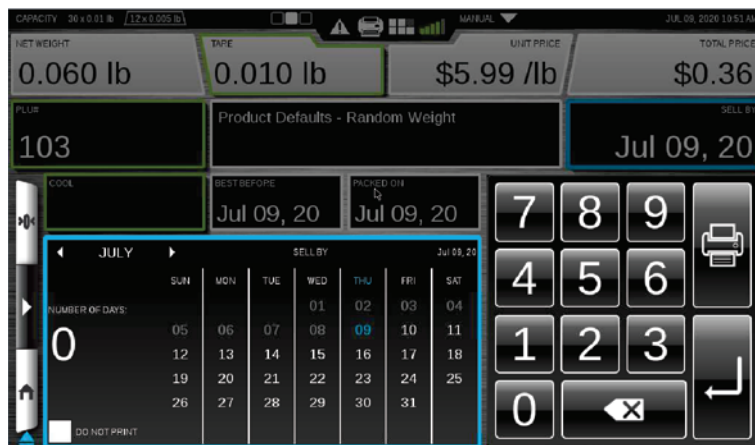

The current date will display in blue. Use the arrows next to the month to change to the next or prior month. Select the date OR TYPE the number of days on the Keypad. The maximum is 998 days. If you do not want this information to appear on the label, TOUCH the Do Not Print box. A check mark will appear in the box when selected.

**NOTE:** If a product is configured in supervisor mode to NOT print the date, the Do Not Print box will be checked. However, if the operator changes the date, the system defaults to the unchecked state.

**NOTE:** Adding days to the Sell By field will automatically add days to the Best Before field in proportion to the days configured for that PLU.

**NOTE:** This screen is used to temporarily change the product and shelf life fields that will be printed on the label. It may be used to select which fields not to print on the label. These changes are temporary and will be lost when a new product is selected.

To change or add a graphic to the label: TOUCH the Primary Graphic ID and SELECT a graphic from the list or SELECT None from the list to remove the graphic. For additional graphics, use the same process for the Additional Graphic ID fields.



To print additional label information: Additional information, such as Expanded Text, Recipes, Allergens, Nutrition Facts Panel, and Cooking Instructions can be printed on separate labels.



**NOTE:** To change or add a graphic to the Label and to print additional label information can be located on Screen 3 of the scale.

**NOTE:** Nutrition Facts Panel includes high level information. Additional information may be included on the label.



## Running a Product

Running a product is the basic function of the operator. This function allows the operator to enter the PLU, weigh the product, and print the label.

**NOTE:** If the PLU number is not known, use the search feature to find the desired product. See [Using the Search Function](#) for more information.

**NOTE:** The PLU# is the default field for the keypad.

From the **Operator Screen**, TOUCH a Flashkey –OR– TYPE the product number on the Numeric Keypad. You may need to



the product information on the Operator Screen.

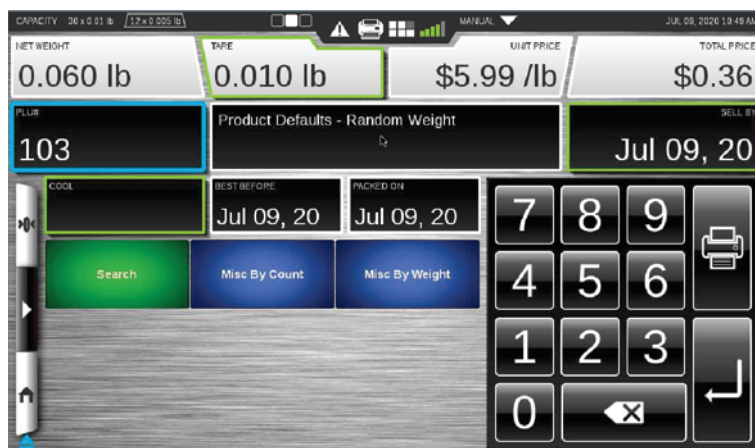

To run Normal Manual mode: Place the product on the scale.



To run in Production Entry Mode: Enter the various PLU's in the scale and the number of labels to be printed for each. TOUCH the



To run in Accumulate Items Mode: Enter Product PLU in the scale. Place product on the scale if the item is sold by weight. If the item is sold by count, enter the quantity. Choose "Add Item". If another item is to be included choose "Add Item". Repeat until order is complete.

Operator can remove an item on the list by selecting "Remove Last Item". To clear the entire order, select "Remove all Items" On final item, select "Add Item and Print" to print the label.



Some PLU's may require information to be entered before the print icon can be used. This is called a forced field and is configured in Supervisor mode. It can be identified by the red field with a blue highlight. Enter the required information. The example shown requires the Unit Price to be entered before the product label can be printed.

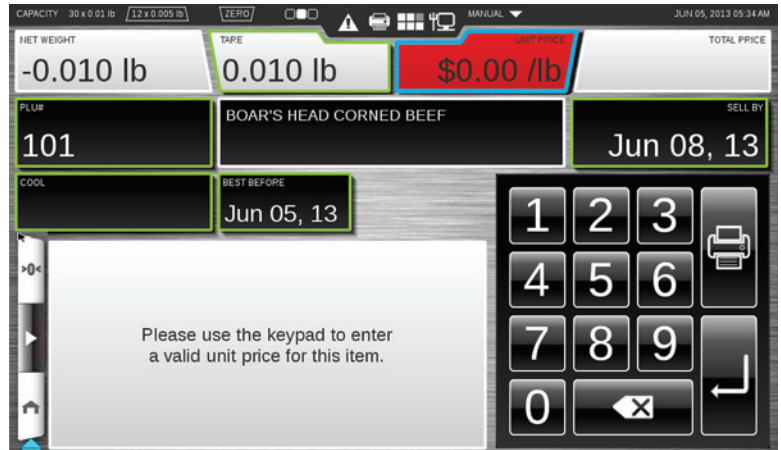

To Print Multiple Labels: After selecting the PLU, TOUCH Print Multiple Labels. The scale will automatically ask you how many labels to print. Using the keypad, select the number of labels and TOUCH print on the keypad.

**NOTE:** Multiple Labels are in the Dynamic Content area and can be added in the Flashkey Editor in either Operate Mode or Supervisor Mode.

**NOTE:** Multiple Labels only works with By Count Items and Fixed Weight Items.

Using Create COOL



COOL. You should now see the *Create*

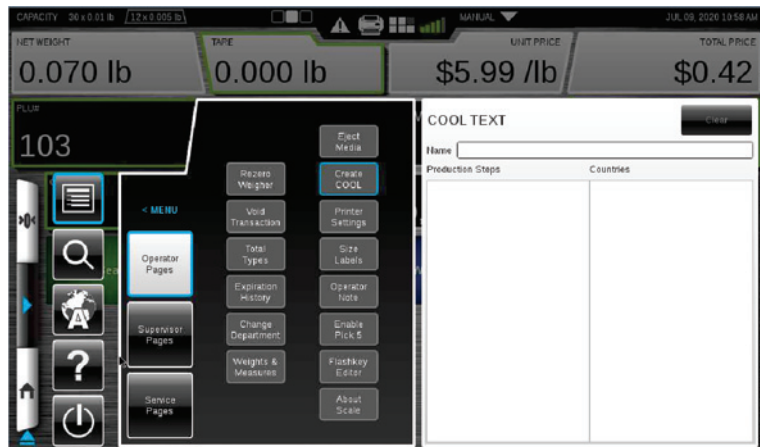

To create COOL text: SELECT the appropriate production step from those listed in the Production Steps box. Repeat this procedure to SELECT the country from the list in the Countries box in which the production step was performed. The production step and country selected will be displayed in the COOL Text name box. TOUCH the Add To Shortlist button to create this COOL option. If needed, TOUCH the Clear button to delete the COOL text.

To exit this window: TOUCH anywhere outside of the Create COOL Window or the Operator Pages box. TOUCHING the Home button will result in losing the current PLU information.

## Modifying the Printer Settings

Settings.

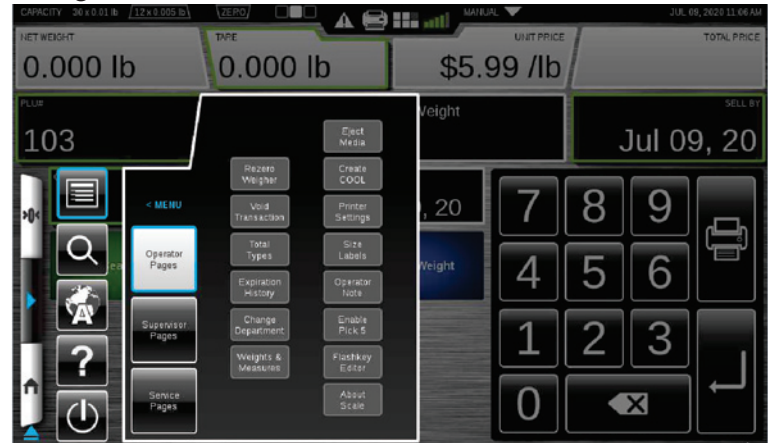

You should now see the *Printer Settings Window*.

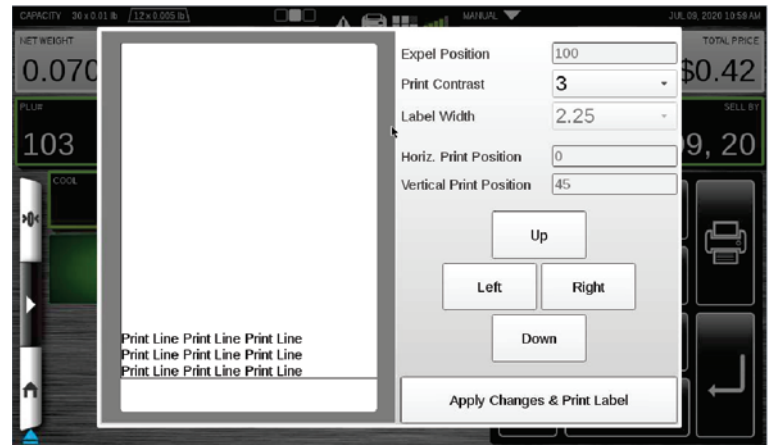

To change the Print Contrast: TOUCH the Print Contrast field and SELECT a number from 0-7. TOUCH the Apply Changes & Print Label button to save changes and print a sample label.

**NOTE:** Use the lowest contrast level that produces acceptable print to preserve print head life. A value of 0 is the lightest and 7 is the darkest.

To change the Horizontal Print Position: TOUCH the Left or Right buttons to move the print to the left or the right on the label. TOUCH the Apply Changes & Print Label button to save changes and print a sample label.

To change the Vertical Print Position: TOUCH the Up or Down buttons to move the print up or down on the label. TOUCH the Apply Changes & Print Label button to save changes and print a sample label.

To exit this window: TOUCH anywhere outside the Printer Settings Window. All changes made will be saved when the window is exited.

## Viewing Expiration Label History

This screen is used to view the Expiration Label History Records. An Expiration Label can be printed for an opened item (i.e. a deli meat loaf). This page will show the user the items that have had expiration labels printed. Additionally, it will show what items have expired in the past two days and those about to expire.



ration History. You should now see the *Expiration Label History Window*.



Red text Items: These are products whose shelf life have expired. The red text makes the items easily identifiable.

Blue text Items: These are products that have not yet expired, but have less than 24 hours until they do expire. The blue text make the items easily identifiable in order for the Operator to select the items for proactive solutions. This may include discounts and sample platters in order to push the items.

Black text Items: These are products that have Shelf Life Expiration dates of more than one day.

PLU # Column: The Product Number of the item that an Operator has printed a shelf Life Expiration Label.

Expiration Day Column: The date, in days, when the product expires.

Time Column: The time of day when the product expires.

Description Column: The product description of the item that had a Shelf Life Expiration Label printed.

To exit this window: TOUCH anywhere outside of the Expiration Label History Window.

## Selecting Total Types



Types. You should now see the *Total Types Window*.

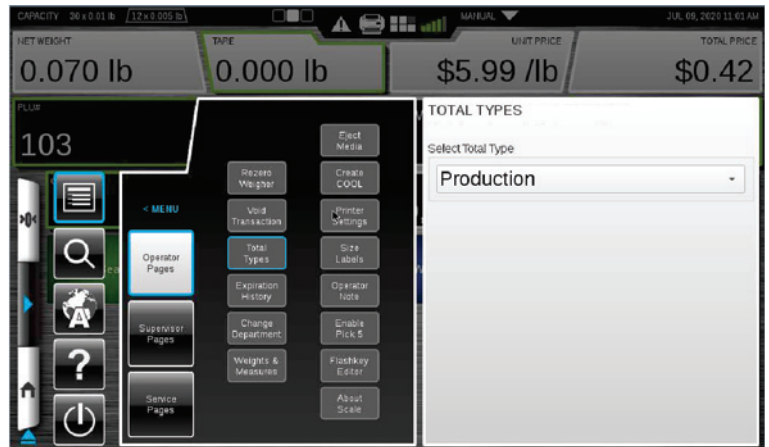

To select a Total Type: TOUCH the Total Type field and SELECT a Total Type.

To exit this window: TOUCH anywhere outside the Total Types Window.

## Voiding a Transaction



Transaction. You should now see the *Void Transaction Window*.

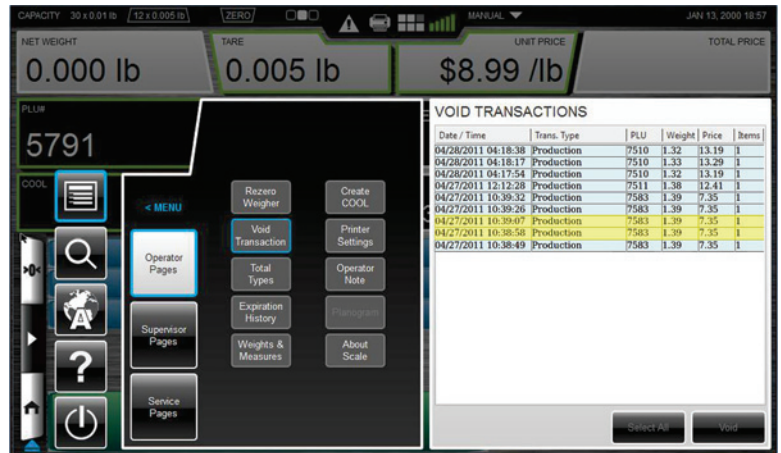

To Void a Transaction: TOUCH the Transaction to highlight it (multiple transactions can be selected if desired) and TOUCH the Void button. ALL the highlighted transactions will be voided. There will be no further indication on the screen that the transaction has been completed. Void does not remove the item from the database.

To exit this window: TOUCH anywhere outside the Void Transaction Window.

## Rezero the Weigher

There are two ways to rezero the weigher. Either is acceptable and will yield the same result.

1. Ensure that nothing is on the scale platter. From any screen,

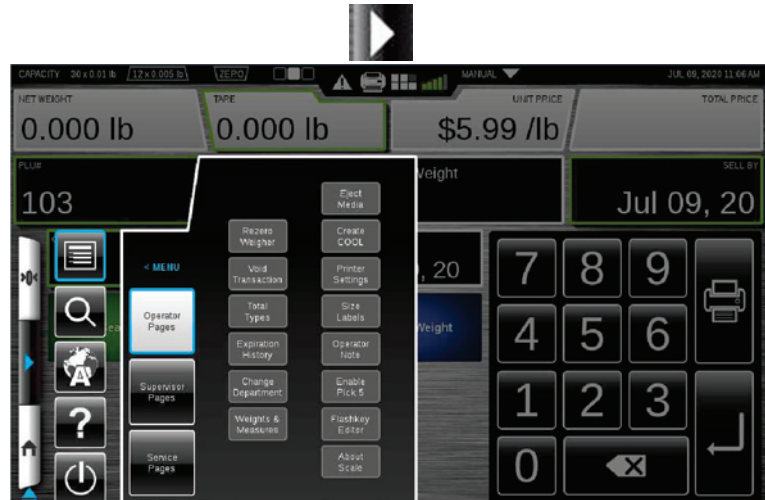

A message box will appear briefly; no other action is required.

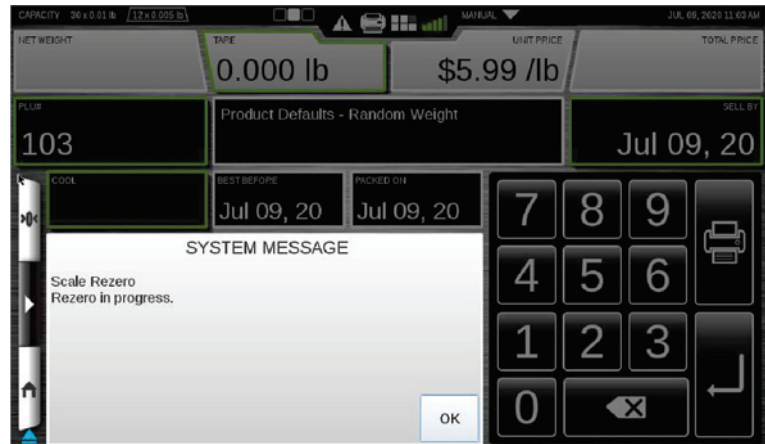

If system message does not automatically dismiss, TOUCH OK to dismiss message.

**-OR-**

2. Ensure that nothing is on the scale platter.

From the main operator screen, TOUCH the Rezero Icon 

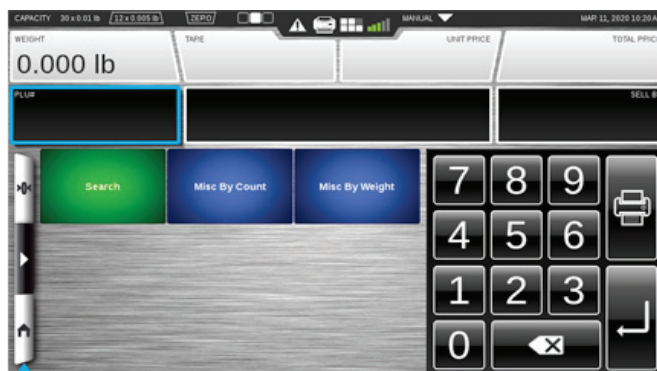



## Using the Search Function

From any

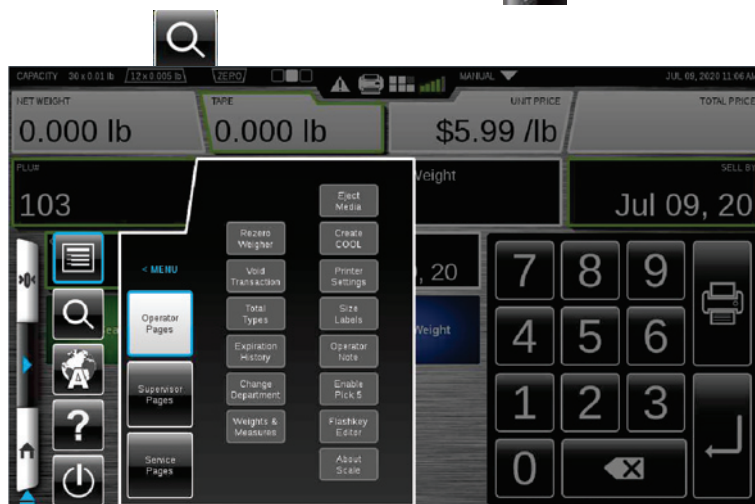

You should now see the *Search Window*. A search can be performed by a product number or by a product description.

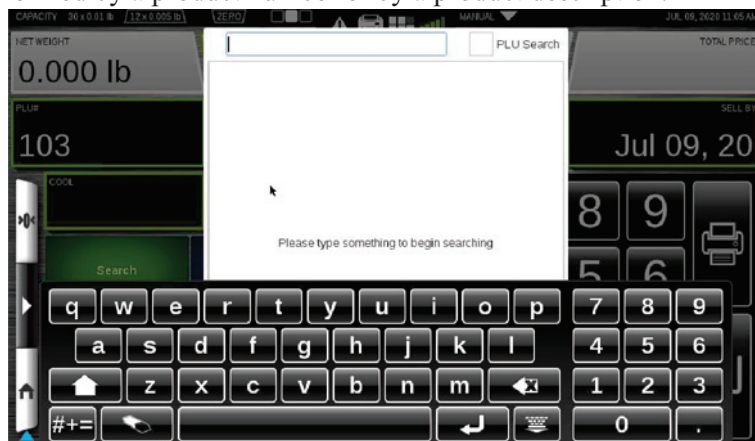

To perform a Search by PLU: TOUCH the PLU Search check box. TYPE the PLU number using the keyboard.

To perform a Search by Description: TYPE the letters or numbers on the keyboard describing the product. As you enter characters the search will begin automatically.

TOUCH the scroll bar arrows to the right of the box containing the product list to scroll up or down and view all of the products listed.

SELECT the desired product on the list. The *Operator Screen* for the selected product will be displayed.

To exit this window: TOUCH anywhere outside of the keyboard or Search Window.

**NOTE:** The search function may be disabled by the supervisor.



**Viewing Product Notes**

If a product note is available, a Product Note message will appear when the PLU is entered.

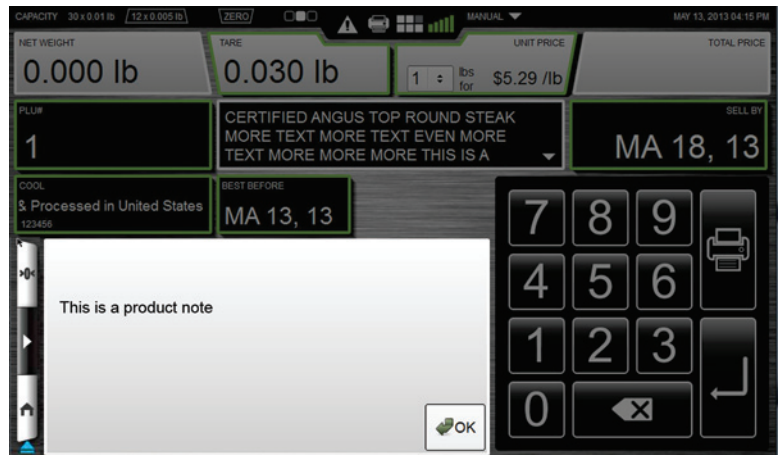

To exit this window: TOUCH OK.

## Viewing Operator Note

From any  
tor Note.

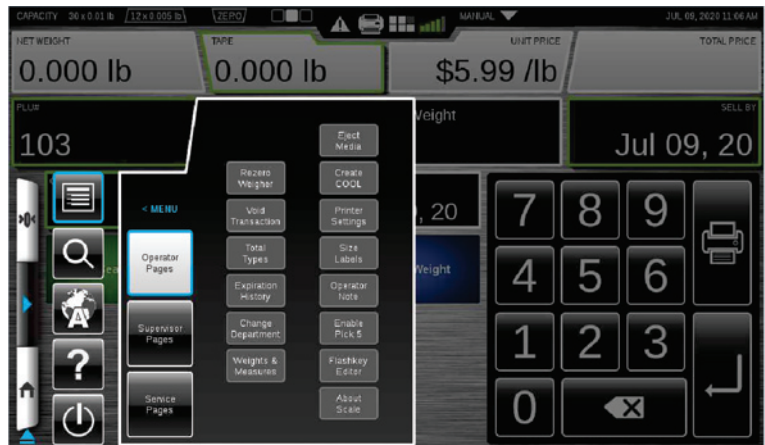

You should now see the *Operator Note Window*. This is only available if there is a note.

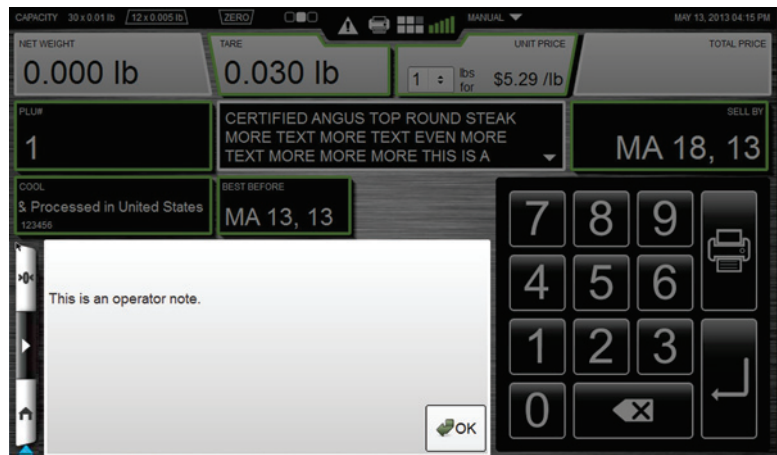

To exit this window: TOUCH OK.



Viewing About Scale Information



Scale.

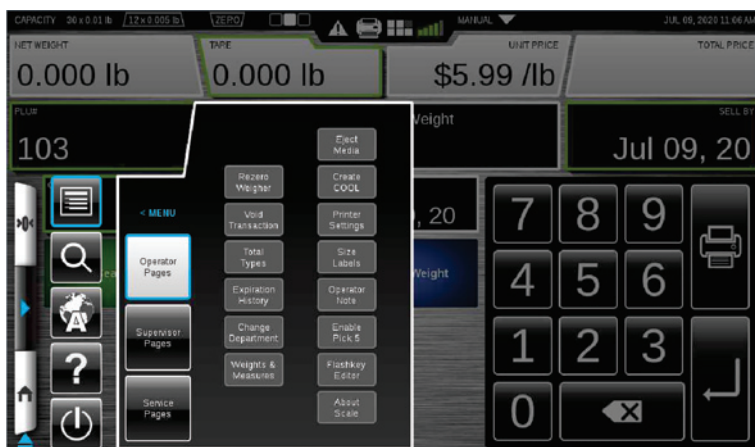

You should now see the *About Scale Window*.

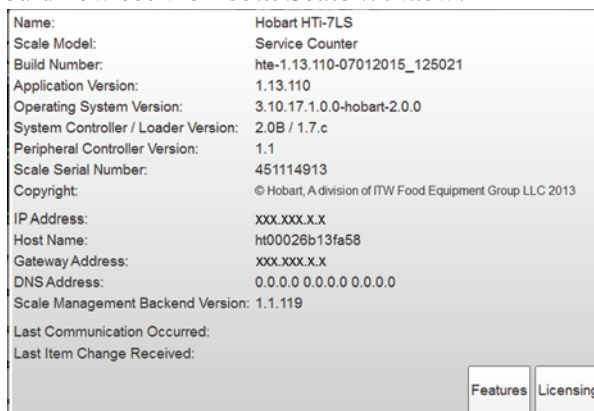

TOUCH Features to view a list of currently installed features associated with this scale.

TOUCH Licensing to view a list of any optional license installed on this scale system.

To exit this window: TOUCH anywhere outside of the window.

**Help**

This scale has an Operator Manual loaded on the scale.

To access the Operator Manual

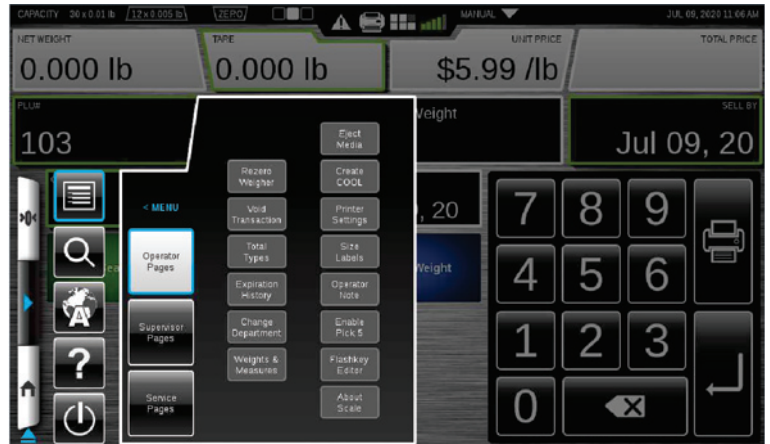

You should now see the Operator Manual and the Multimedia



To minimize: TOUCH the Home button. The Multimedia icon should stay on the Home button.

To exit this window: TOUCH the check mark in upper right corner or anywhere outside of the window.

**NOTE:** The scale has preloaded six operator training video and five Supervisor training videos on the HT Scale operation and usage. To access, scroll for links at the bottom on the left column in operator manual.

## Using Now Serving Tickets

The HTi and HTm Scale Systems can be configured to work with a Flashkey Editor . A flashkey will be configured to advance the now serving number. The location of the flashkey can be configured to appear in any of the dynamic content areas of the screen. TOUCH the flashkey to advance to the next now serving number.

## Using the Flashkey Editor

The Flashkey Editor allows the operator to set up quick and easy access to various scale functions and frequently used PLU's. The flashkeys will appear in the dynamic content area of the center operator screen. Additional flashkey features can be configured in supervisor mode.



key Editor.

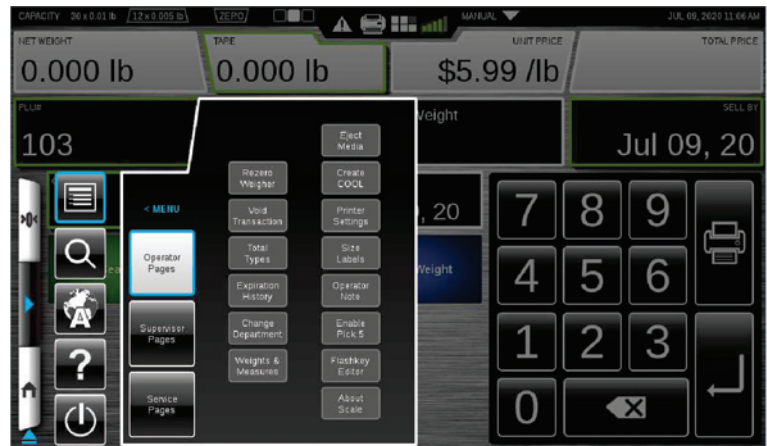

You should now be on the *Flashkey Editor Screen*.

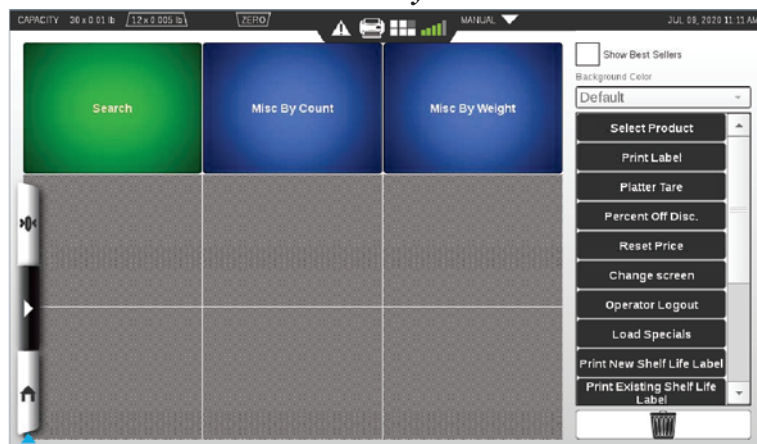

**NOTE:** TOUCHING a flashkey will cause a description of that flashkey to populate in the Function Description box.

To add a flashkey: SELECT a flashkey from the list on the right and drag the flashkey to the desired location on the grid. TOUCH the scroll bar arrows to the right of the box containing the flashkeys to scroll up or down and view all of the flashkeys listed.

To remove a flashkey: TOUCH, hold, and drag the flashkey to the trash can.

To change the background color: TOUCH Change Background Color on the upper right side of the screen. You should now see a list of background colors available.

To use the Best Sellers: TOUCH Use Best Sellers check box in the upper right of the screen. A check will appear in the check box when Best Sellers is activated. The scale automatically determines the best-seller keys based on sales data from that individual scale.

**NOTE:** The background color for best seller keys cannot be changed.

To exit the Flashkey Editor: TOUCH home icon.



## HTi Self-Service Scale

---

The HTi and HTm Self-Service Scales features an elevated 14 inch touch screen display. Some units are equipped with a bar-code scanner for quick product identification. The consumer can scan the barcode on the product to quickly find the correct product to be weighed.



### HTi Self-Service Scale

All other operating functions of the self-service scale are similar to the HTi/HTm Scale System.



---

## Using Self Service Mode

---

The Self Service Mode is designed to allow the consumer to use the scale. In this mode, the consumer can enter the PLU, if known, or search for the PLU by using the search function. On units equipped with a scanner, the consumer can scan the barcode. Once the correct PLU is selected, the consumer can place the product on the scale platter and then touch the Print Label. The consumer cannot modify any information about the product information. The consumer will be able to enter a by-count value when required.

**NOTE:** The language displayed in Self Service Mode can be toggled by touching the alternate language button on any screen.

To set scale in Self Service Mode: See [Scale Operation Mode Setup](#).

**NOTE:** In order for the operator to set the scale in Self Service Mode, this feature must be turned on in Supervisor Mode.

**NOTE:** Once the scale is placed in Self Service Mode, it will remain in this mode even after a system reboot or power failure until the scale is set for a different mode. See [Leaving Self Service Mode](#).

To use the scale in Self Service Mode: Follow the on-screen instructions. TOUCH the green button on the screen with the phrase, “Touch here to begin”

**NOTE:** The scale can be configured in supervisor mode to skip the “Touch here to begin” screen and start on the *Enter PLU Screen*.



You should now see the **Enter PLU Screen**.

**NOTE:** The *Enter PLU Screen* can be configured in supervisor mode to display the apple with the PLU example, as shown below, or a set of Best Seller flashkeys.



If the Item Code (PLU) is known, enter the item code on the keypad, then press Enter. You should now see the **Product Screen** for the selected item.

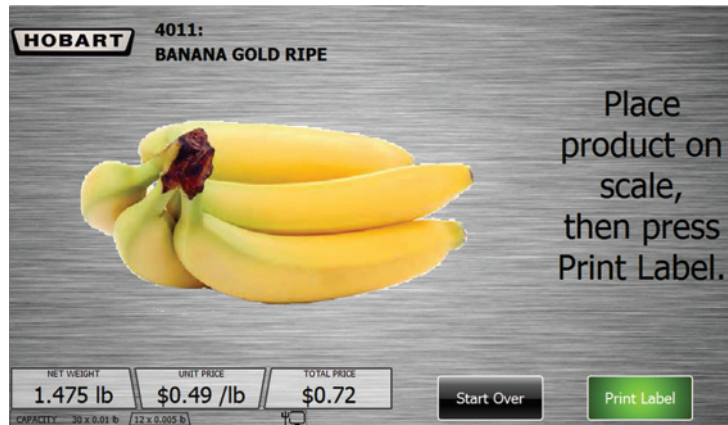

Place product on scale, then press Print Label.

The label will print and a screen will show the consumer a hand removing the label from the printer. Retrieve and Apply Label.



Additional information about the product may be available and will display on the **Product Screen** when the item code is entered. Here is an example of a **Product Screen** showing Nutrifacts with Expanded Text.

**HOBART**

**4011:**  
**BANANA GOLD RIPE**

Serving Size 100 g		Servings Per Container 1	
Amount Per Serving		Calories from Fat 15	
		% Daily Value *	
Total Fat	2 g	3%	
Saturated Fat	1 g	3%	
Trans Fat	0		
Cholesterol	0 mg	0%	
Sodium	3 mg	0%	
Total Carbohydrate	83 g	29%	
Dietary Fiber	10 g	40%	
Sugars	47 g		
Protein	4 g		
Vitamin A	5 %	Vitamin C	12 %
Calcium	2 %	Iron	6 %
Vitamin B6		Vitamin B12	
Zinc			

**Banana Description:** Bananas grow, not on trees, but on tall plants about 25 feet high. Each stem or shoot from the trunk of the plant produces about 10 "hands" with about 12 "finger" or bananas on each. The entire stem, which produces fruit only once, is trimmed off and the individual hands are packaged for shipping. Storage: To ripen, keep uncovered at room temperature. For speedy ripening, enclose bananas in a brown paper bag. Selection: Bananas should be of uniform shape and color regardless of

Place product on scale, then press Print Label.

NET WEIGHT <b>1.485 lb</b>	UNIT PRICE <b>\$0.49 /lb</b>	TOTAL PRICE <b>\$0.73</b>
-------------------------------	---------------------------------	------------------------------

Start Over

Print Label

Here is an example of a **Product Screen** showing Nutrifacts without Expanded Text.

**HOBART**

**4012:**  
**NAVEL ORANGES JUMBO**

Serving Size 100 g		Servings Per Container 1	
Amount Per Serving		Calories from Fat 15	
		% Daily Value *	
Total Fat	2 g	3%	
Saturated Fat	1 g	3%	
Trans Fat	0		
Cholesterol	0 mg	0%	
Sodium	3 mg	0%	
Total Carbohydrate	83 g	29%	
Dietary Fiber	10 g	40%	
Sugars	47 g		
Protein	4 g		
Vitamin A	5 %	Vitamin C	12 %
Calcium	2 %	Iron	6 %
Vitamin B6		Vitamin B12	
Zinc			

Place product on scale, then press Print Label.

NET WEIGHT <b>1.480 lb</b>	UNIT PRICE <b>\$0.89 /lb</b>	TOTAL PRICE <b>\$1.32</b>
-------------------------------	---------------------------------	------------------------------

Start Over

Print Label

Here is an example of a **Product Screen** showing Expanded Text only.



Here is an example of a **Product Screen** showing Frequent Shopper information with Expanded Text.

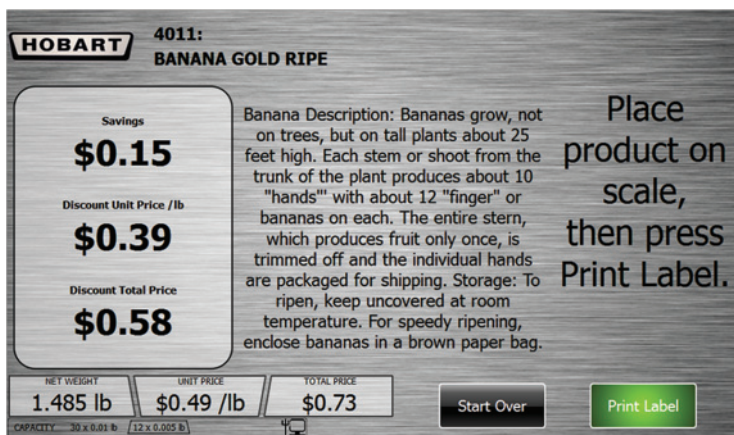



To use the Search function in Self Service Mode: From the *Enter PLU Screen*, TOUCH the Search button. You should now see the *Self Service Search Screen*.



TOUCH the letter boxes on the left of the screen to narrow down the product search. TOUCH the UP or DOWN arrows on the right of the screen to scroll through the selections. TOUCH the Best Sellers button to select a product from the *Best Sellers Screen*.

**NOTE:** The scale automatically determines the best-seller keys based on sales data from that individual scale.

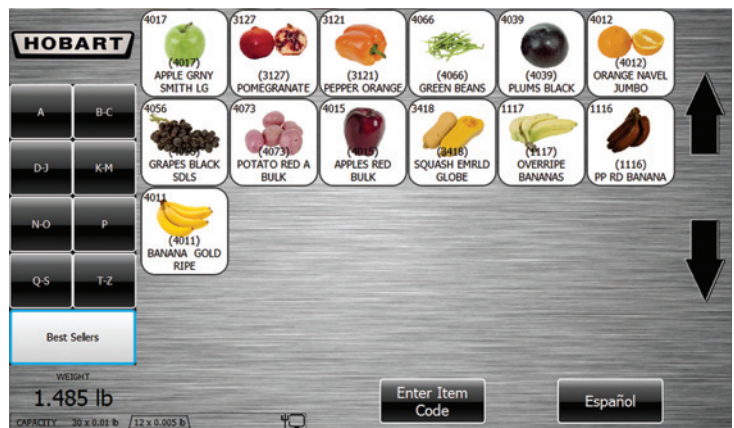

Once the item is found, TOUCH the product flashkey and the **Product Screen** for the selected item will appear. Follow the on-screen directions to use the scale.

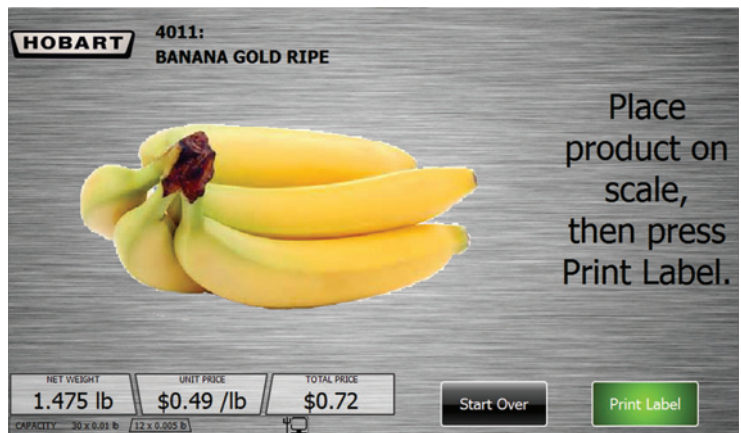

To Exit the Self Service Search Screen, TOUCH Enter Item Code. The **Enter PLU Screen** will now appear.

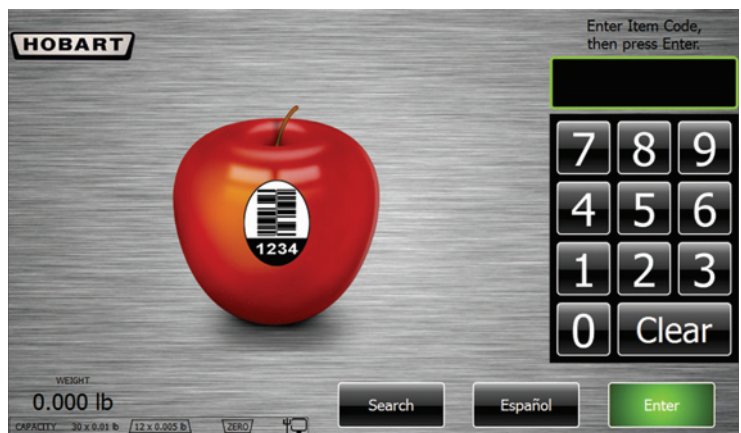

To Rezero the Scale in Self Service Mode: TOUCH the lower left area of the screen that displays the capacity.

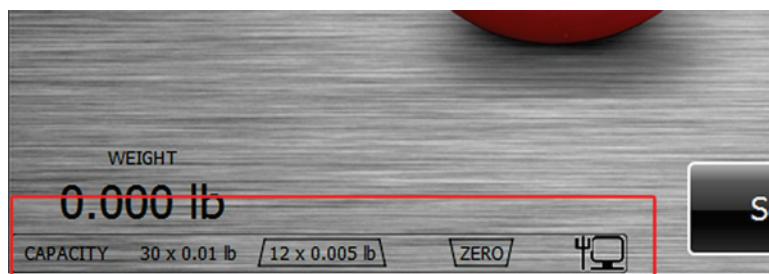

**TOUCH the CAPACITY area**

You should now see the *Self Service Mode Weights and Measures Screen*.

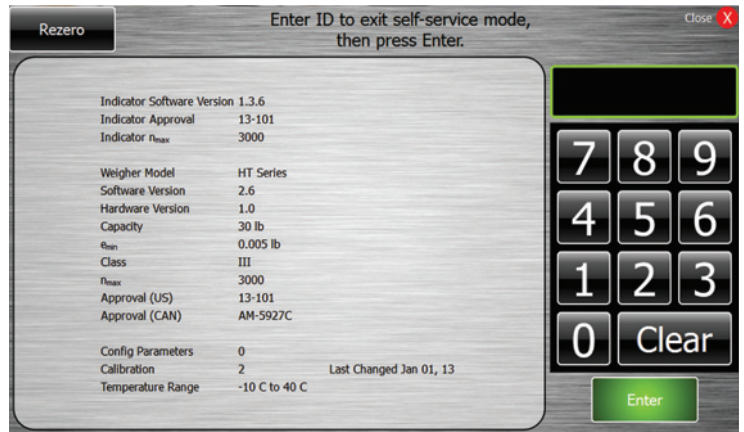

TOUCH the Rezero button. A message box will appear briefly; no other action is required.

To view Weights and Measures information with the Scale in Self Service Mode: TOUCH the lower left area of the screen that displays the capacity.

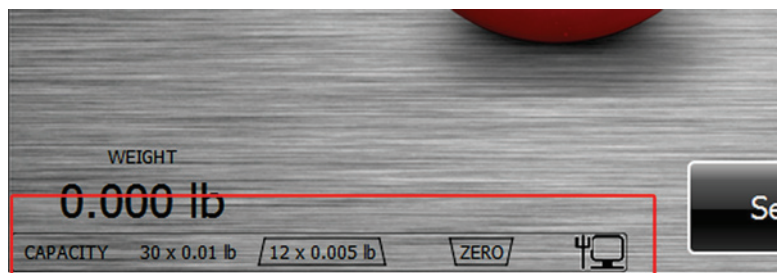

**TOUCH the CAPACITY area**

You should now see the *Self Service Mode Weights and Measures Screen*.

**NOTE:** The information on this screen will vary depending on the peripherals attached. An example screen is shown below.

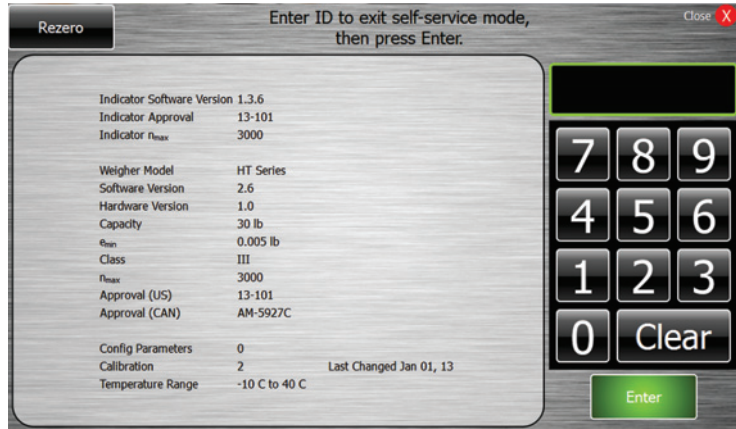

To Exit the *Self Service Mode Weights and Measures Screen*, TOUCH the red Close X in the upper right area of the screen.

## Leaving Self Service Mode

Once the scale is placed in Self Service Mode, it will remain in this mode even after a system reboot or power failure until the scale is set for a different mode. There are two ways to remove the scale from the Self Service Mode. One method is to use a valid operator ID. The other method is to use a standard USB Supervisor/Service key.

To leave Self Service Mode by using a valid operator ID: TOUCH the lower left area of the screen that displays the capacity.

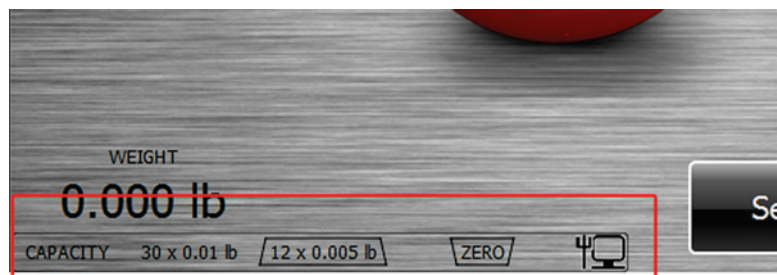

**TOUCH the CAPACITY area**



You should now see the *Self Service Mode Weights and Measures Screen*.

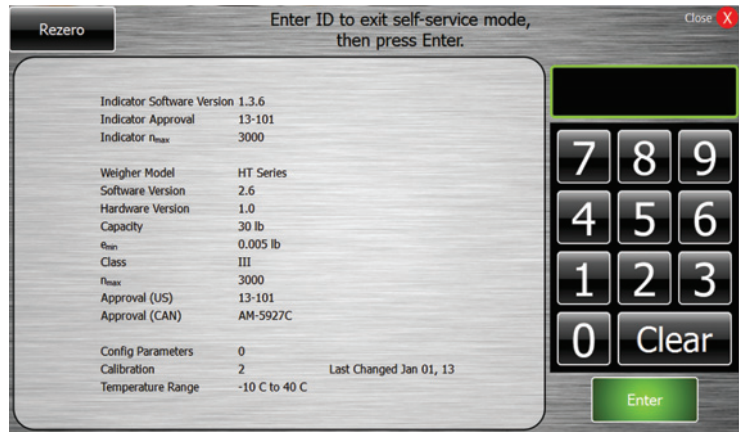

Enter a valid operator ID to exit self-service mode, then press Enter. The scale will revert to standard operation.

**NOTE:** A default operator ID of “1010” with level 1 scale access will be in the scale database to allow exit from Self Service Mode without a USB Supervisor/Service key.

To leave Self Service Mode by using a standard USB Supervisor/Service key: Insert the USB Supervisor/Service key into the USB port on the side of the scale. TOUCH the lower left area of the screen that displays the capacity.

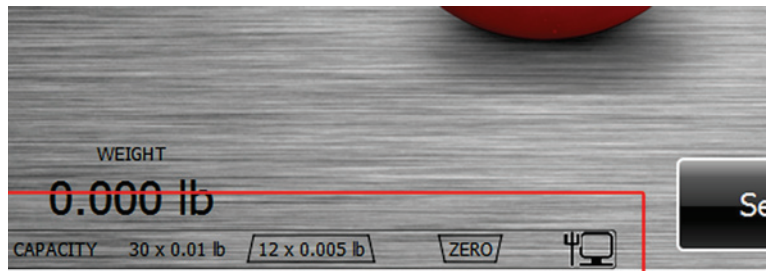

**TOUCH the CAPACITY area**

You should now see the *Self Service Mode Weights and Measures Screen*.

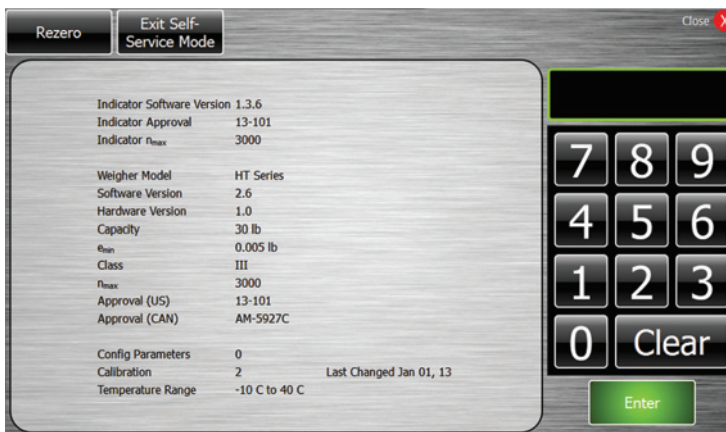

TOUCH the Exit Self-Service Mode button in the upper left area of the screen. The scale will revert to standard operation.

## Using Meal Planner

If a product is configured in supervisor mode as a “Build a Meal” item, the consumer will see the following screen when the PLU is entered. You should now see the *Build a Meal Screen*.

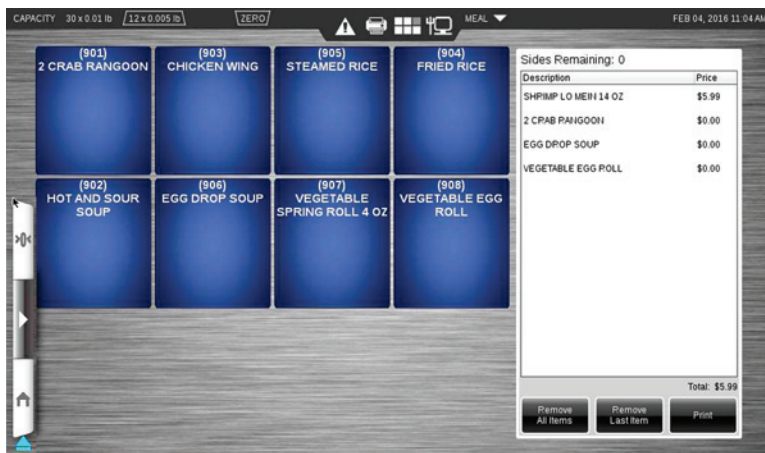

**NOTE:** Build a Meal PLU's can be configured to include a set number of side items in the sale price. The list will display how many items can be selected.

To add items to the list: TOUCH the flashkey of the item to add. The Sides Remaining number will decrease for every item added.

To remove items from the list: TOUCH the item in the list and then TOUCH the Remove Selected button.

To remove all items from the list: TOUCH the Remove All Items button.

To remove the last item added to the list: TOUCH the Remove Last Item button.

To print the label after all side items have been selected: TOUCH Print.

To exit the Meal Planner: TOUCH home icon.

## Using Pick 5

The Pick 5 feature offers the ability to specify parameters for pick 5 promotions and allows the operator to print labels specific to pick 5 items.

1. From Operator pages, choose “Enable Pick 5”.

**NOTE:** Operator can now use scale for Pick 5 configuration.



2. Background is orange when Pick 5 is enabled and the PLU has Pick 5 parameters. This offers a visual indication to the operator that they are in Pick 5 mode.

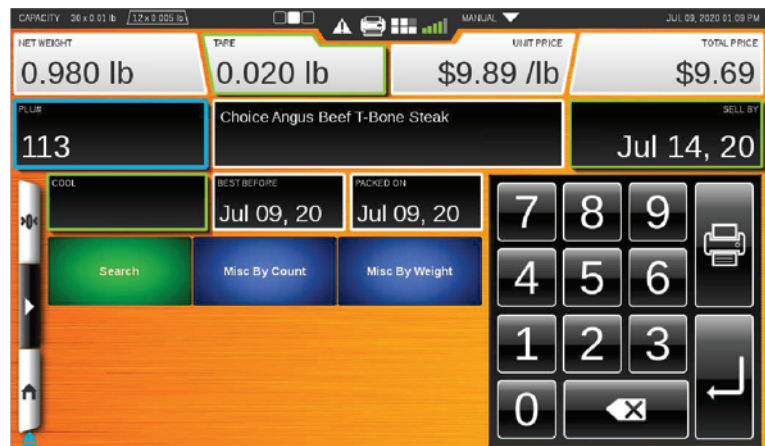

Pick 5 items must fall within the price or weight range designated. If they do not fall within the Pick-5 defined range, an error is generated until the parameters are met.

1. If weight/price is not met, those fields will be highlighted red, indicating an error.

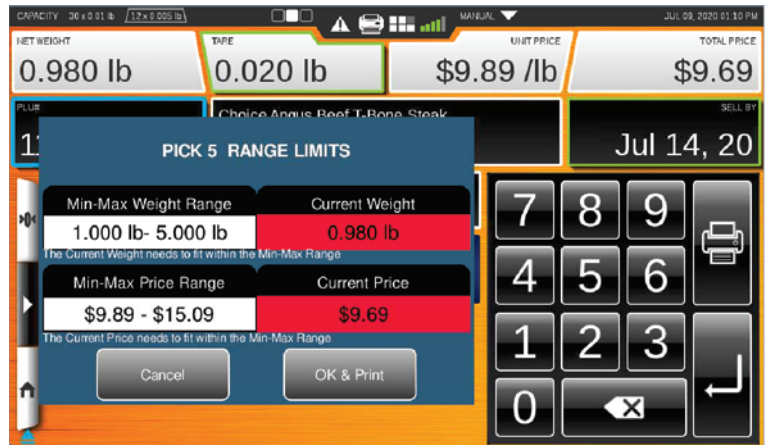

2. When Pick 5 weight and price parameters are met, fields will be highlighted green. The operator can print a label.

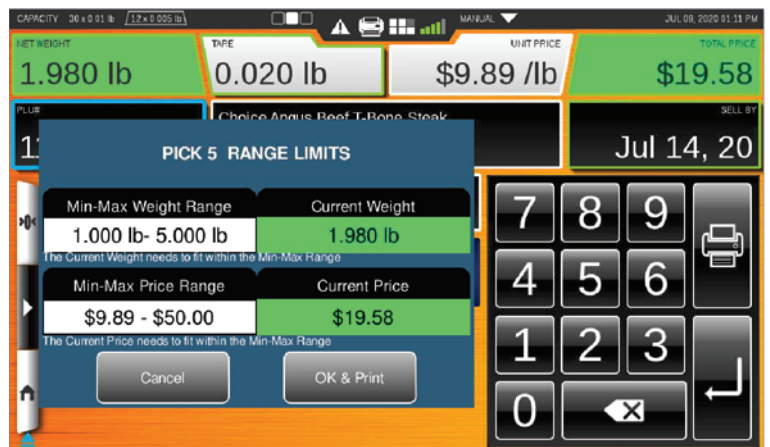

**To Exit Pick 5 Mode:**

Navigate to Operator pages, select “Disable Pick 5”.  
Operator can now resume normal scale operations.

## Multi Department

Multiple departments may be defined by the supervisor. TOUCH Change Department, you should now see the *Select Department Screen*.

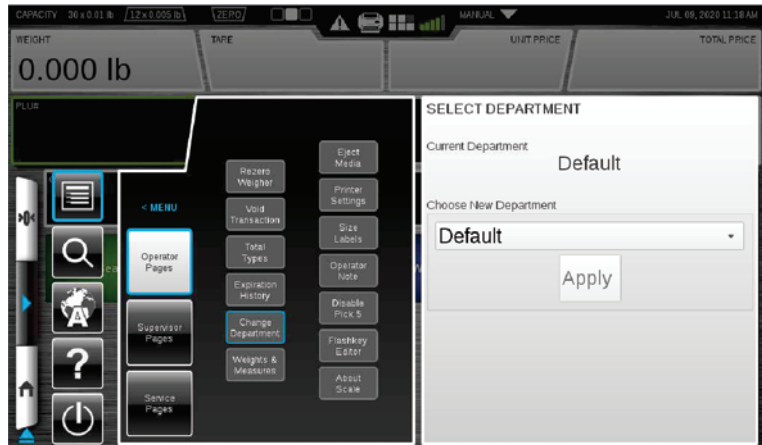

Select the desired department and TOUCH Apply. The selected department will now be shown in the top, right hand corner of the screen.

**NOTE:** If Default is selected, no department will be displayed in the top, right hand corner of the screen.





## Cutting Test

The cut test allows the user to track the weight of a primary product as it is divided up into secondary products of varying value. A single active session is the default setting. Multi session may be allowed by the supervisor. When cut test is enabled then Start Cut Test flashkey will be present. TOUCH Start Cut Test, you will now be in the *Start Cut Test Screen*.

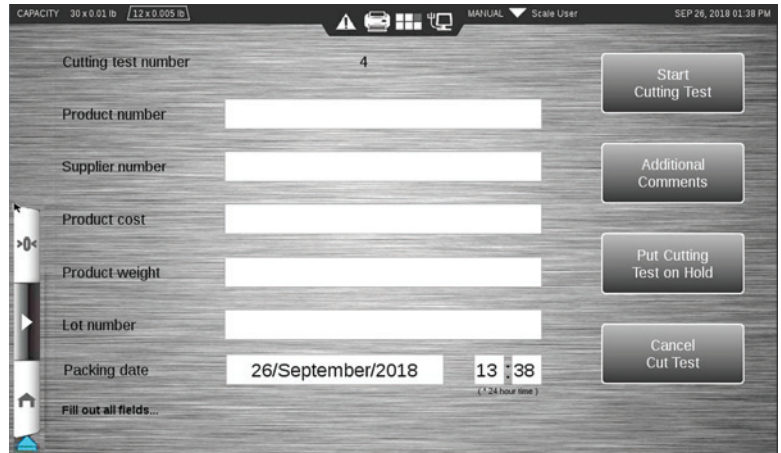

Fill out all fields then TOUCH Start Cutting Test. The Flashkeys designated by the supervisor for the specified product number will now display. Select the desired product to be weighed. The cutting test will now be active. When a cutting test is active the background will be yellow and three flashkeys will be displayed; Finish Run, Finish Cutting Test, and Put Cutting Test on Hold.

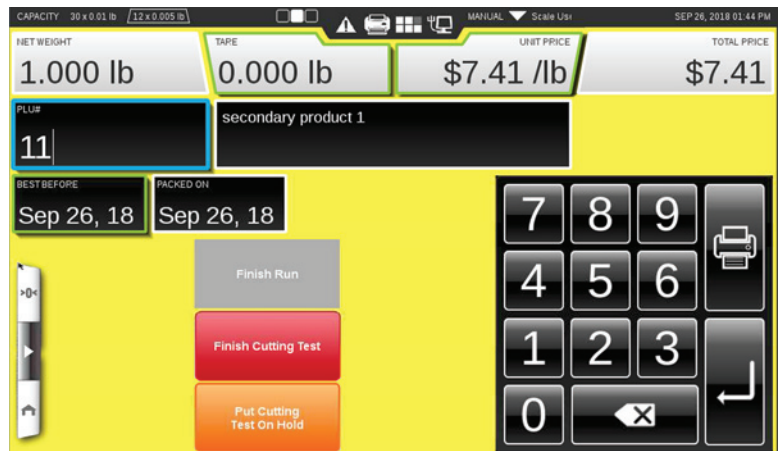

Cutting tests may be suspended by touching Put Cutting Test on Hold. Multiple cutting tests by multiple operators may be allowed by the supervisor.

When all active cutting tests are suspended the cutting test history may be viewed. TOUCH Cutting Test History, you should now see the *Cutting Test History Screen*.

Test	Product number	Operator name	Status	Supplier number	Product cost	Product weight	Lot number	Packing data	
1	2	10	Scale User	Suspended	104795	\$4578.00	85.000 lb	655474	2018-09-26 13:27:30
2	3	0	Scale User	Suspended	\$0.00	0.000 lb			2018-09-26 13:37:42
3	4	10	Scale User	Suspended	988248	\$478.52	99.655 lb	4jh453	2018-09-26 13:43:24
4									
5									
6									
7									
8									
9									
10									

From the Cutting Test History Screen, any suspended cutting test may be resumed.

A cutting test may only be finished while it is active. TOUCH Finish Cutting Test, you will now be in the *Finish Cutting Test Screen*.

Cutting test number: 4      Product cost: \$478.52      Status: Completed  
 Product number: 10      Product weight: 99.655 lb      Packing date: 09/26/18 01:43 PM  
 Supplier number: 988248      Lot number: 4jh453      Operator name: Scale User

PLU	Description	Packages	Weight	Price Per lb	Sale Amount	Participation
112	secondary product 2	1	1.000 lb	\$9.85 /lb	\$9.85	1.00%
211	secondary product 1	1	1.000 lb	\$7.41 /lb	\$7.41	1.00%
3	Waste		97.655 lb			97.99%
4	Total		99.655 lb		\$17.26	100.00%

You may print or save the cutting test details from the final screen.



## Selecting Label Stock Type

The main purpose of this function is to eliminate the need to size new label stock every time the cassette is inserted. HT series scales support up to 10" label stock, in order size the label about 20" of label must be expelled from the scale. If no black line detected in the backup paper the it is a continuous label stock what has been loaded. To prevent wasting 20" of label stock every time, a new button has been added in the Operator Pages options. This option will allow the operator to select what kind of label stock is loaded, the option by default is to **Size Labels**. In such case the scale will continue to perform a label sizing every time the label cassette is loaded. If the **Continuous Label** option is selected, then when label cassette is loaded there won't be any label sizing and an informational message will be displayed.

TOUCH Size Labels, you should now see the *Select Size Labels Screen*.

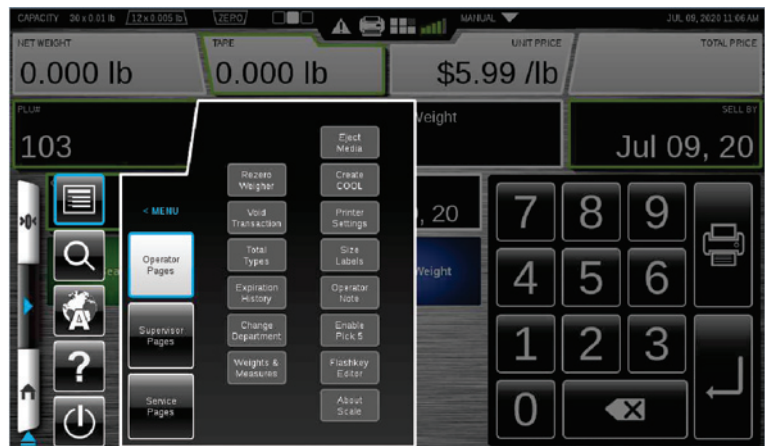

Select the desired label type. If continuous stock is selected, a system message will appear.

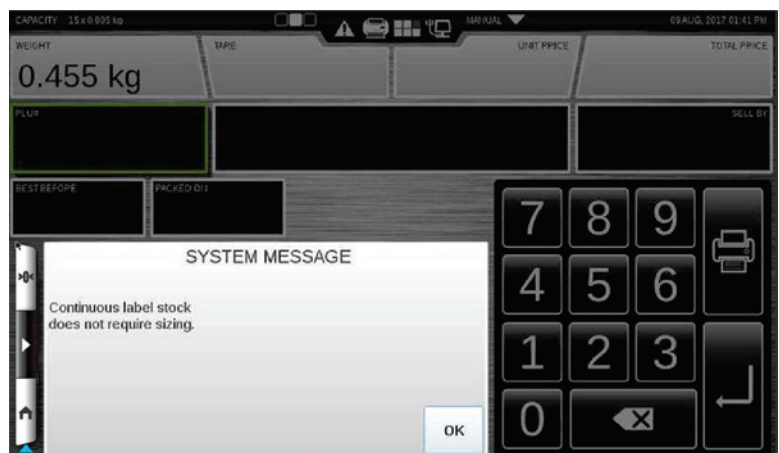

If system message does not automatically dismiss, TOUCH OK to dismiss message.



## Chapter 4: Maintenance & Cleaning

### Maintenance & Cleaning

#### Removing the Label Cassette

To remove the Label Cassette:

1. Press down on the black label Cassette Eject Button. The Label Cassette will partially eject 1 to 2 inches.

Grasp the Label Cassette and slide it toward the front.



#### Installing the Label Cassette

To install the Label Cassette:

1. Line up the Guide Rail on the Label Cassette with the track on the base of the scale.
2. Slide the Label Cassette into the Printer Area.

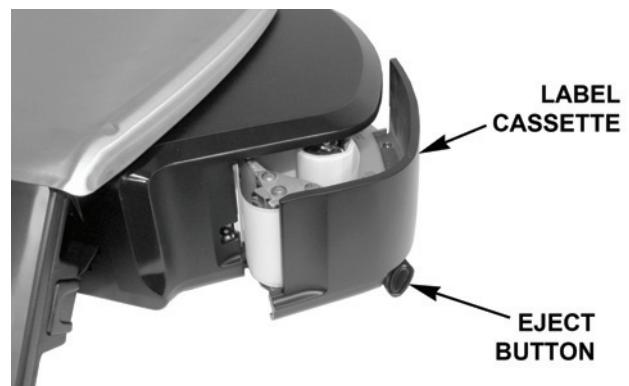

3. There will be a slight resistance the last 1 to 2 inches of travel as the mechanism engages. The motion should be similar to closing a cash register drawer.
4. Press it *firmly* until you hear the cassette latch lock into place.

## Removing the Label Roll

---

To remove the Label Roll:

1. Remove the Label Cassette.
2. Lift the metal Captive Key up and remove any remaining labels and backing paper from the take-up spool.
3. Remove the label roll from hub.

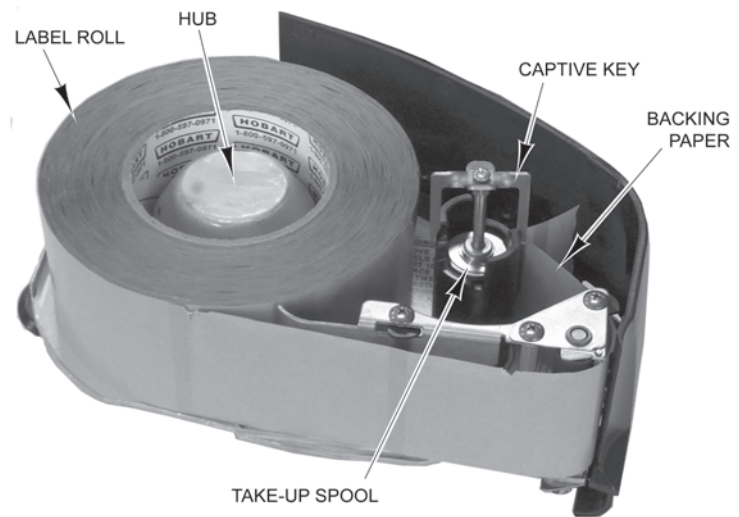

---

## Loading the Label Roll

---

### To load the Label Roll:

1. Remove labels from the first 10 inches of the label roll.
2. Place the label roll on the Hub in the Label Cassette.
3. Thread the leader between the Peel Bar and Label Cassette Housing.

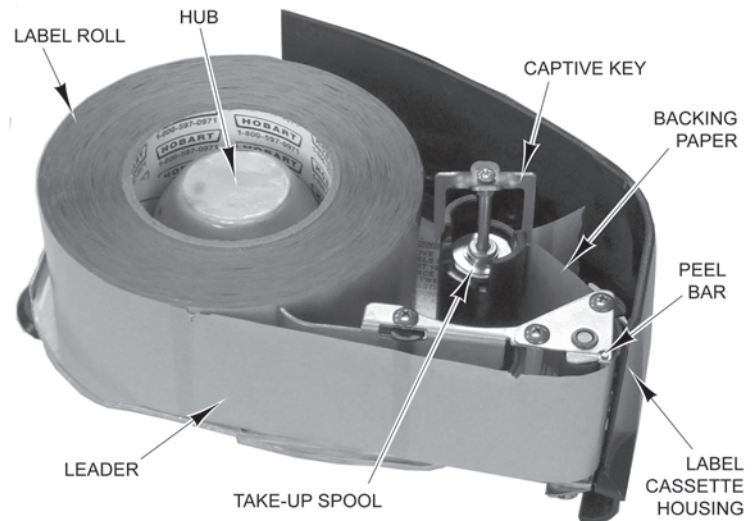

4. Pull the Captive Key up and wrap leader around the take-up spool, then Slide the Captive Key down onto spool.
5. Turn spool counterclockwise until edge of first label is even with peel bar.
6. Install the Label Cassette.

---

### Removing the Auto-Cutter Label Cassette (for Linerless Labels)

---

To remove the “Auto-Cutter” Label Cassette:

1. Gently open auto-cutter cartridge
2. Press down on the black Cassette Eject Button. The label cassette will partially eject 1 to 2 inches.
3. Grasp the Label Cassette and slide it toward the front.

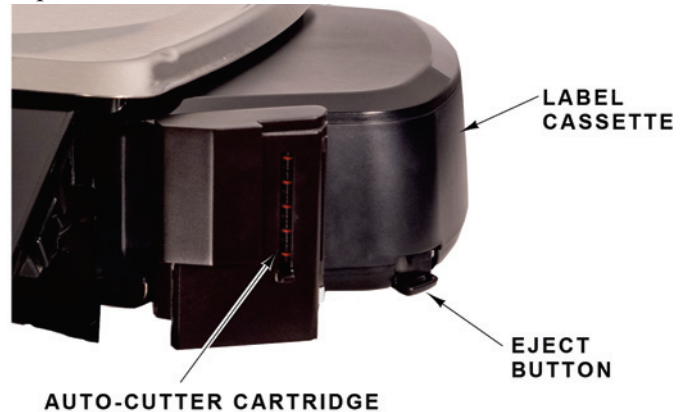

---

### Installing the Auto-Cutter Label Cassette (for Linerless Labels)

---

To install the “Auto-Cutter” Label Cassette:

Auto-Cutter

1. Ensure the Auto-Cutter cartridge is open.

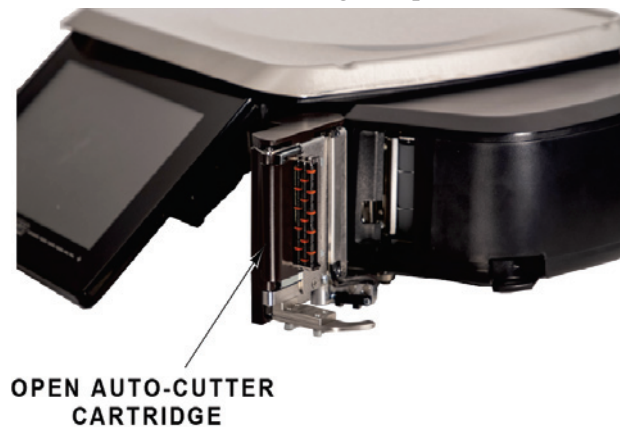

2. Line up the Guide Rail on the Label Cassette with the track on the base of the scale.
3. Slide the Label Cassette into the Printer Area.

4. There will be a slight resistance the last 1 to 2 inches of travel as the mechanism engages. The motion should be similar to closing a cash register drawer.
5. Press it firmly until you hear the cassette latch lock into place.
6. Gently close Auto-Cutter cartridge.



### Removing the Label Roll from Auto-Cutter Cassette (for Linerless Labels)

Auto-Cutter Cassette:

1. Pull back label hold down arm.
2. Remove label roll from hub.

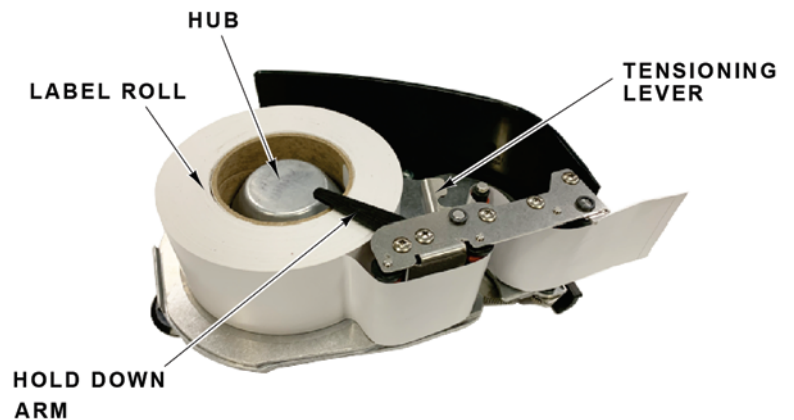

## Loading the Linerless Label Roll into Auto-Cutter Cassette

Auto-Cutter Cassette:

1. Pull back label hold down arm.
2. Place the linerless label roll on the hub in the Label Cassette.
3. Release label hold down arm.

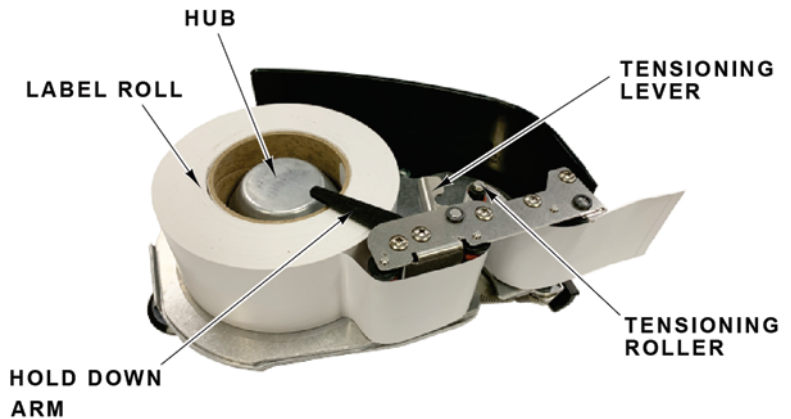

4. Peel out approximately 6 inches of linerless label stock beyond the label cassette housing.
5. Pull tensioning lever forward to release label tensioning roller.
6. Thread label stock behind label tensioning roller.

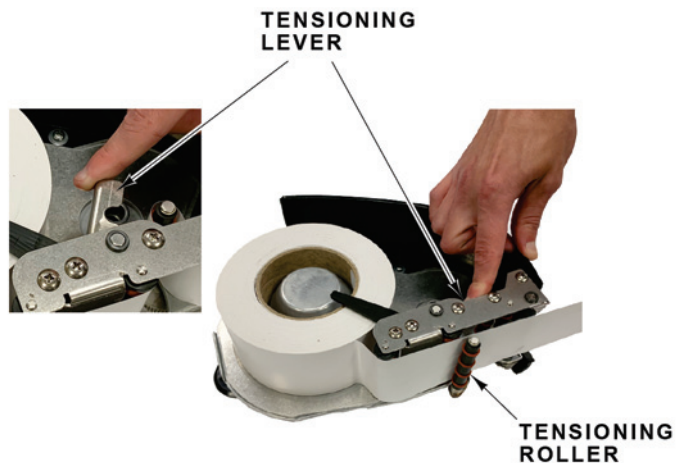



7. Gently release tensioning lever.
8. Install label cassette, ensuring auto-cutter cartridge is still open.
9. Feed label through auto-cutter cartridge.

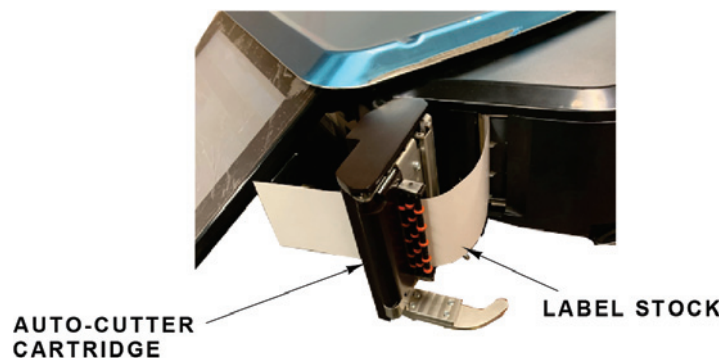

10. Gently close auto-cutter cartridge – Labeler will automatically size label stock upon closure.

---

### Removing the Scale Platter

---

To remove the Scale Platter:

1. Lift up on the front lip of the platter.
2. Pull it straight up to remove.



---

### Replacing the Scale Platter

---

To install the Scale Platter:

1. Locate the Platter Locating Studs on the bottom of the platter.
2. Line the Studs up with the hole in the Center of the Rubber Platter Mounts on the sub-platter.

## Adjusting Console Position

---

The HT Series Scale System is designed so you can place the scale anywhere in your operation and adjust the screen for best visibility.

The Console may be pivoted into different positions. To adjust the console position:

1. Press the two Console Adjustment Buttons located on each side of the Console.
2. Pivot the Console to the desired position for best viewing.
3. Release Console Adjustment Buttons to lock it into place.



---

## Leveling the Scale

---

There are four Scale Feet located underneath the Scale System. You may need to adjust these feet slightly in the event the scale is not sitting on the table/case properly or the scale is not level.

Proper adjustment of these feet helps you maintain the proper scale balance.

To check Scale balance: (for HTs and HTi only)

1. Remove the Platter.
2. Locate the Level on the Scale sub-platter. It can be seen

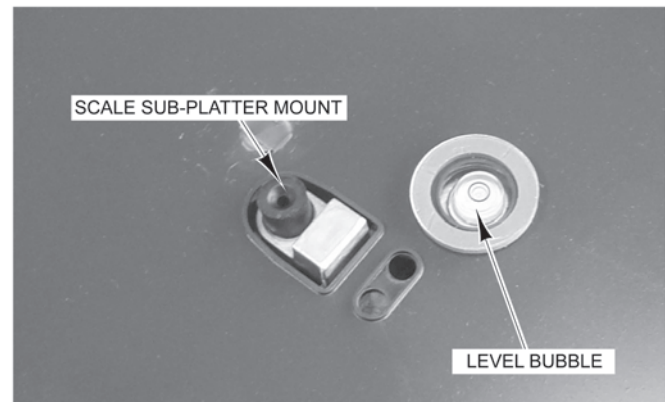

3. Adjust the feet until the “bubble” is in the middle of the level.

To **increase** the length of the scale feet:

1. Rotate the feet in a counterclockwise direction, when looking up at the feet.
2. Rotate the lock nut until it is firmly against the scale base housing to lock the adjustment in place.

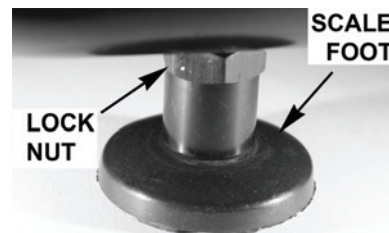

To **decrease** the length of the scale feet:

1. Rotate the feet in a clockwise direction.
2. Rotate the lock nut until it is firmly against the scale base housing to lock the adjustment in place.

**NOTE:** Maintaining a level condition is a legal requirement and is the user’s responsibility.

## Leveling the HTm Scale:

To check Scale balance: (for HTm only)

1. Perform a visual check.
2. Use a level on the platter surface, checking both the x and y axis.



3. Adjust the feet until the level is balanced or reads 0°.

**NOTE:** The ValueMax feature on the HTm scale will automatically compensate for up to 3° out-of-level measurements. However, examining and leveling the scale on a regular basis should be included in regularly scheduled maintenance activity.

If the scale is more than 3° out-of-tilt, an error will appear on the screen:

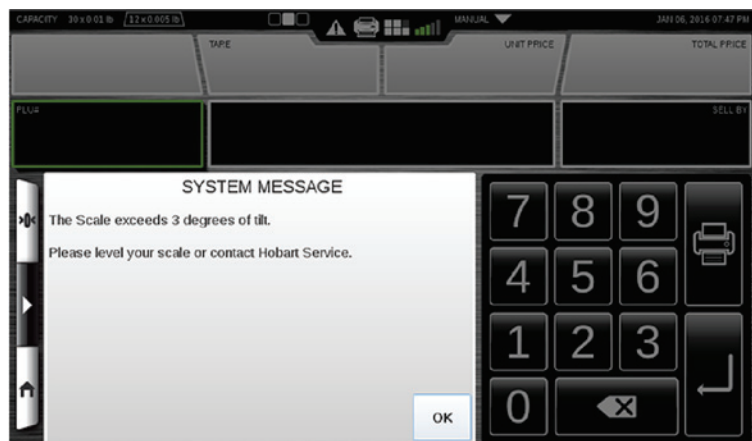

When this occurs, adjust the feet until the level reads 0°. The error message will disappear when the scale is within the acceptable level range.

## Checking Printhead Dot Status

On the HTm device, if CodeChecker is enabled for the Operator, Printhead Dot Status can be viewed.

To view Printhead Dot Status:

1. Navigate to Operator pages.
2. Press “Printer Dot Status”.



CodeChecker will “run” and display printhead dot status.

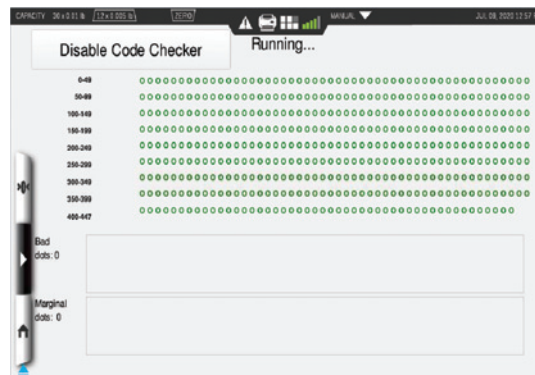

**NOTE:** This screen offers a visual indication of printhead health. Dots appear green when fully functioning. Dots will appear red if they are blown or “bad”. Printhead should be serviced only when:

- 1) Blown dots are hindering the print quality and label print quality is unacceptable.

**AND**

- 2) Cleaning the printhead does not improve the print quality.

Hobart recommends cleaning the printhead on a regular basis to ensure optimum print quality.

### Cleaning the Printhead

---

The printhead of your HT Scale System should be cleaned approximately once each week, or whenever labels are obstructed due to a residue buildup on the printhead and/or roller. It is a good idea to clean the printhead roller whenever a new roll of labels is installed. To obtain a Printhead Cleaning Kit, contact your local Hobart Representative; request Part Number 00-913096-00001.

**NOTICE** *Do not use a metal tool on the printhead.* This could scratch or break the printhead. In addition, monitor the printer to look for labels stuck on the printer parts. If found, remove these labels at once following the instructions given below.

**NOTICE** Do not dampen labels, electronic parts, or connections. Do not allow water to enter the openings in the housing. This could damage the scale system.

1. Use the scraper from the Printhead Cleaning Kit to remove stuck-on label stock.
2. To remove burnt-on adhesive, gently rub the printhead surface with the eraser from the Printhead Cleaning Kit.
3. Clean the roller with cleaner and swabs.
4. Allow the printhead and roller to dry before loading the labels.

**Cleaning the Exterior of Scale**

Carefully clean the exterior of the HT Scale System with a clean sponge or cloth and a warm water and mild detergent solution.

**NOTICE**

Do not dampen labels, electronic parts, or connections. Do not allow water to enter the openings in the housing. This could damage the scale system.

**Troubleshooting**

In the event that your HT Scale System does not operate as expected, please reference the following troubleshooting steps before calling for service.

If you are experiencing problems with the system, the following scenarios may be of help.

Problem	Possible Cause	Action/Solution
There is no display on the display unit.	You may not have power running to the system.	Verify the power cord is plugged into a working electrical outlet.
The Operator ID was not accepted.	You may have entered the wrong ID.	Verify that you are entering the proper ID. If correct, have your supervisor check the ID number. See <i>Logging onto the System</i> for more information.
Product number was not found.	You may have entered an invalid product number.	Verify the product number.
System prompts you to take a label. No label is present.	A portion of the label may be 'hidden' in the label exit.	Make sure that the label exit is clear.
Partial non-printed label is exposed.	The labels may be improperly threaded.	Verify that labels are properly threaded.
System prints blank labels or partially printed labels.	The labels may be improperly threaded or the printhead or roller may be dirty.	Check to see that labels are threaded properly. If the problem persists, clean the printhead using the Hobart Printhead Cleaning Kit.





## Chapter 5: Hands Free Login

### Introduction

The Hands-Free Pager Device (HFPD) is used to log into and notify the user of issues with Hobart equipment. The purpose of this document is to inform the user on how to properly configure and use the HFPD. The following steps assume that the scale in use has the `_SCALE_HANDSFREEDevice` license and the `htilinux-feature-hfpd` feature installed.



### Hands-Free Pager Device Hardware

On the front side the handsfree device has three main components, the display, the speaker and the button.



### HFPD Display

The HFPD is equipped with an e-ink display. The display is used to display messages and status information about the beeper. The display is split into four sections, the logo section, the shift mode section, the information section, and the message section.

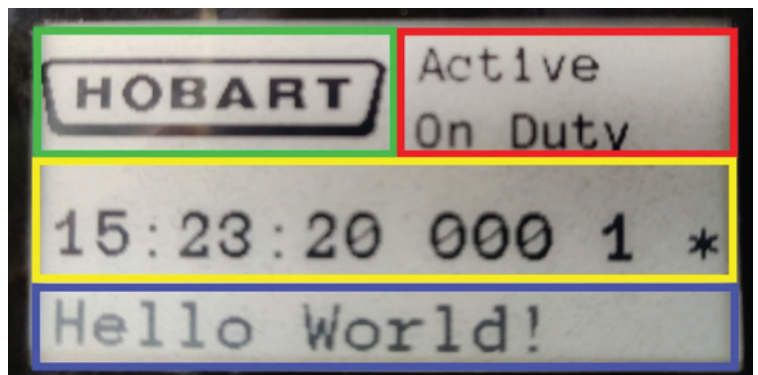

## Logo Section

The logo section, highlighted by the green box, displays the company logo. The logo can be set using the *Hands Free Login App*.

## Shift Mode Section

The shift mode section of the device, highlighted by the red box, tells if the device is currently active or inactive. For more information about active and inactive mode see *Device Operation*. The shift text can be configured using the Hands Free Login App.

## Information Section

The information section, highlighted by the yellow box, displays information about the recently received message or the user name associated with the device. If there is no message, the user name is displayed. If there is a message displayed on the screen, the information section displays the time the message was sent, the scale that sent the message, the number of messages queued, and the status of the device. In the information section displays '15:23:20 000 1 \*'. The first section, '15:23:20' represents the time the message was sent. The second section, '000' is the scale number. '1' is the number of messages on the queue, and the '\*' is the status of the scale. Possible status symbols are displayed in the following table.

Status Symbol	Description
'!'	Low battery
'>'	Message queue overflowed
'<'	One or more messages queued
'*'	Message queue empty

## Message Section

The message section, highlighted by the blue box, displays the oldest message in the queue. If multiple messages are queued the user must press the *HFPD Button* to clear the displayed message and see the next.

---

**HFPD Button**

---

The button, illustrated in red, is used to dismiss messages and switch between active and inactive modes. When a message is sent to the device it will be displayed on the Message section of the HFPD Display. To clear this message press and release the button. Clearing one message will display the next queued message if one exists. The button can also switch the device between active and inactive modes. To switch between modes, hold the button for approximately two seconds. The device will then beep and refresh the display. Embedded in the button is an LED ring. The LED ring will slowly flash when the device battery is less than 10%.

---

**HFPD Speaker**

---

The speaker, highlighted in white, is used to notify the user of new messages, and key presses. The speaker can be configured using the *Hands Free Login App*.

---

**Device Operation**

---

The Hands-Free Login device has two different modes of operation, active and inactive.

Active Mode

The Hands-Free device broadcasts information for Hobart equipment to pick-up. This allows Hobart equipment to connect to the HFPD to send messages and update configuration.

**NOTE:** The HFPD must be in active mode to enable automatic login.

Inactive Mode

Use this mode to save battery. The Hands-Free device does not broadcast its information and will not receive any messages when it is in Inactive Mode.

---

**Device Configuration**

---

Before you can configure HFPD and operators, you must install the license. `_SCALE_HANDSFREEDEVICE`

---

**Associating with Operators**

---

Associating the HFPD with a scale operator allows the user to be automatically logged in when they approach the scale and then automatically become logged out when they leave the scale. Completing the following section will associate an operator with a HFPD.

1. Navigate to the “Supervisor Pages”.

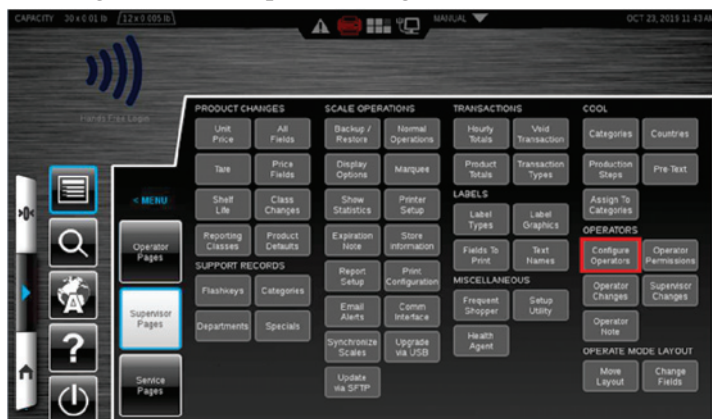

2. Press the “ALL FUNCTIONS” button near the bottom of the

Operator ID

Access level

Operator name

Preferred language

Operators must login to run the scale

Automatically create hands free operators

ID	Access	Language	Operator Name	TAG ID
C1:4A:2A:51:D4:50	1	English		C1:4A:2A:51:D4:50
C2:42:04:DE:99:7D	1	English		C2:42:04:DE:99:7D
E6:F6:86:38:CB:B8	1	English		E6:F6:86:38:CB:B8
E9:A8:BB:1F:01:BF	1	English		E9:A8:BB:1F:01:BF
F1:FC:22:91:E5:96	1	English		F1:FC:22:91:E5:96

3. Next select Operator ID that matches the MAC address of the HFPD you are associating.

**NOTE:** The mac address can be found in the battery compartment, below the batteries, or in the message field after a device reboot.

4. Next fill in the following information; Access level, Operator name, and Preferred language, to their desired values. If the box for “Automatically create hands free operators” is checked, it will prompt the scale to automatically detect and create operators for each HFPD within range.
5. Once the HFPD is configured, return to the home screen to complete the association process.

## Hands Free Login App

The Hands-Free Login App is used to detect and configure HFPDs. Through the app you can change fields and settings, send messages, and update firmware for HFPDs. The Hands-Free Login app is installed and licensed by Hobart Technicians.

**NOTE:** Before you can use The Hands-Free App you must have the `_SCALE_HANDSFREEDEVICE` license installed.

To run the Hands-Free Login App

1. First you must swipe down from the top of the screen. This will bring up the app tray.



2. Locate and press the Hands-Free Login App.



## Configuring Hands-Free Pager Device

To configure a HFDP, you must first detect the device using the Hands-Free Login app.

1. Open the Hands-Free Login app. The discovery screen will appear.

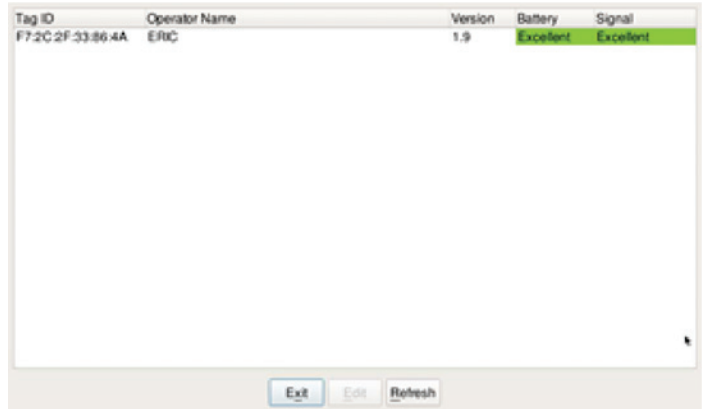

2. To modify device configuration, press the row containing the TAG ID matching the MAC address of your device.
3. Press the Edit button. The device configuration screen will appear.

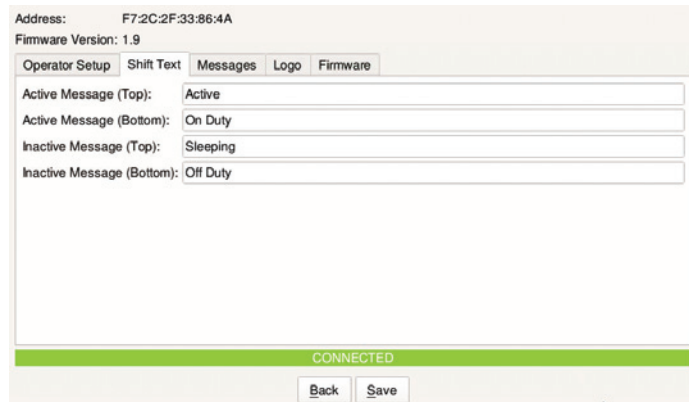

---

## Configuring HFPD Fields and Settings

---

The Hands-Free Login app provides a method for configuring HFPD fields and settings. On the app's Device Configuration page, three tabs are used to configure HFPDs. They are the "Operator Setup", "Shift Text" and "Logo" tabs.

### Operator Setup

The Operator Setup tab allows the user to set the Operator Name, Shift Duration, and Beep Time.

1. Enter the operator name. This will be displayed on the HFPD if there are no messages on the device (there is a 16 character restriction due space of screen).
2. Shift Duration is used to automatically change the to sleeping mode after the set time is reached. Shift Duration can be any whole number value between 0 and 36 hours.

**NOTE:** Setting the Shift Duration to 0 disables the timer.

3. Beep Time specifies the duration of the beep when a message is received, or the button is pressed. The Beep Time can be set to any whole number between 0 and 255. Setting the value to 0 silences the beep timer.

After filling out the desired values press the save button to send the values to the HFPD.

Address: F7:2C:2F:33:86:4A  
Firmware Version: 1.9

Operator Setup | Shift Text | Messages | Logo | Firmware

Device Type: aff1  
OTA Identifier: 0c060107

Operator Name: Hobart User

Shift Duration (hours): 8

Beep Time (ms): 100

CONNECTED

Back Save



### Shift Text

This will show if the device is Active or Inactive. ten characters each.

Active Messages are displayed when the device is active and receiving messages.

Inactive Messages are displayed when the device is in low power mode and not receiving messages.

Fill in the desired values for Active and Inactive messages, press save to send the values to the HFPD.

Address: F7:2C:2F:33:86:4A  
Firmware Version: 1.9

Operator Setup | Shift Text | Messages | Logo | Firmware

Active Message (Top): Active  
Active Message (Bottom): On Duty  
Inactive Message (Top): Sleeping  
Inactive Message (Bottom): Off Duty

CONNECTED

Back Save

### Shift Text

This will show if the device is Active or Inactive. ten characters each.

Active Messages are displayed when the device is active and receiving messages.

Inactive Messages are displayed when the device is in low power mode and not receiving messages.

Fill in the desired values for Active and Inactive messages, press save to send the values to the HFPD.

Address: F7:2C:2F:33:86:4A  
Firmware Version: 1.9

Operator Setup | Shift Text | Messages | Logo | Firmware

Active Message (Top): Active  
Active Message (Bottom): On Duty  
Inactive Message (Top): Sleeping  
Inactive Message (Bottom): Off Duty

CONNECTED

Back Save

## Logo

Images can be uploaded to the HFPD to be displayed in the logo section.

The optimal logo resolution is 128 x 48 pixels. Images other than this size will be scaled to this resolution and may need to be cropped to fit. Acceptable file formats for logos are .bmp, .gif, .jpg and .png.

To upload a new logo

1. Navigate to the Logo tab on the Device Configuration page.
2. Enter the path to the logo in the Logo Filename box or clicking the button with three dots ("...") at the end of the box.

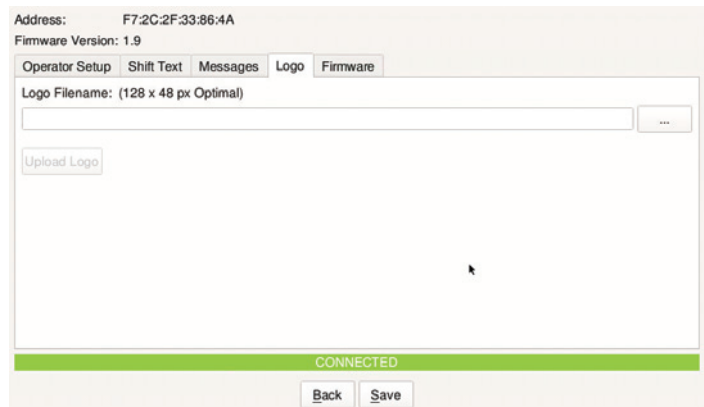

Clicking the button will bring up another window. Here you can navigate to the filename for the Logo you want to upload.

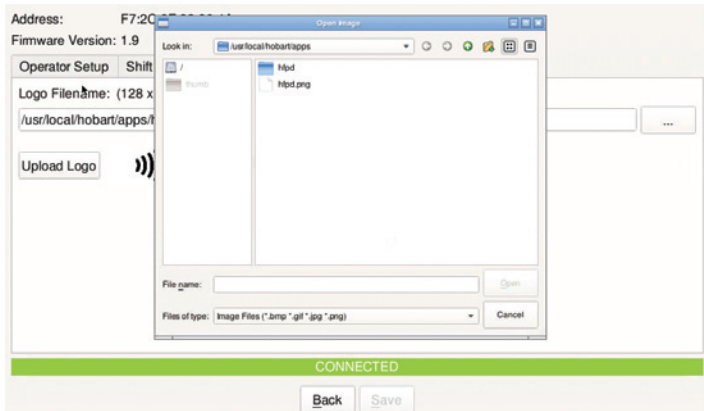

3. Press the Upload Logo button once the logo has been selected. This will send the image to the HFPD. The display will update with the new logo once the HFPD receives the Logo.

## Messages

---

Custom messages can be sent to the HFPD devices and cleared on the device using the Messages tab of the Device Configuration page. The Message field is limited to 16 spaced due to display size.

### To send a custom message

1. Fill the Message Text box.
2. Press the Send Message button.

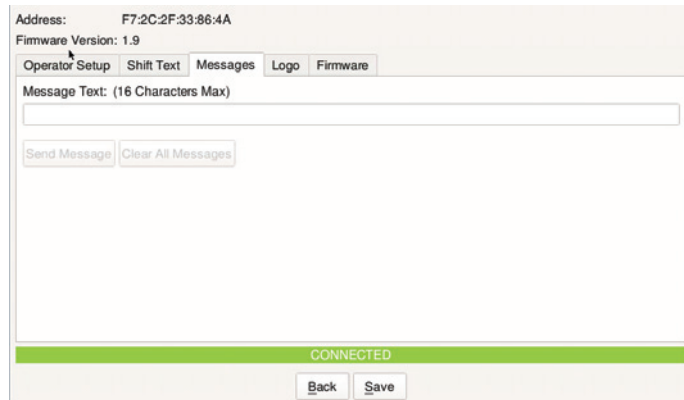

Address: F7:2C:2F:33:86:4A  
Firmware Version: 1.9  
Operator Setup Shift Text Messages Logo Firmware  
Message Text: (16 Characters Max)  
Send Message Clear All Messages  
CONNECTED  
Back Save

### To clear all messages

1. Navigate to the device configuration page for that device.
2. Select the Messages Tab.
3. Next press the “Clear All Messages” button. This will erase all messages on the device.

## Firmware

---

As new features are added and bugs are fixed, new versions of HFPD firmware will be released. The *Hands Free Login App* provides the ability to upload new firmware to HFPD.

## Add Firmware to Scale

As new features are added and bugs are fixed, new versions of HFPD firmware will be released. The *Hands Free Login App* provides the ability to upload new firmware to HFPD.

Firmware must be stored on the scale before information can be uploaded to the HFPD. Feature files are created to provide an easy route for adding new firmware files. Contact Hobart Service to get the latest HFPD firmware feature files. Feature files should be labeled htseries-any-hfpd-application-\*.package.tgz.

To add new firmware to the scale

- 1.. Navigate to the “Supervisor Pages” press the “ALL FUNCTIONS”.
2. Press the “Upgrade via USB” button.
3. Insert the USB drive that contains the feature file into the scale.
4. Press the “Choose Upgrade Firmware File” button. This will bring up the firmware file dialog.

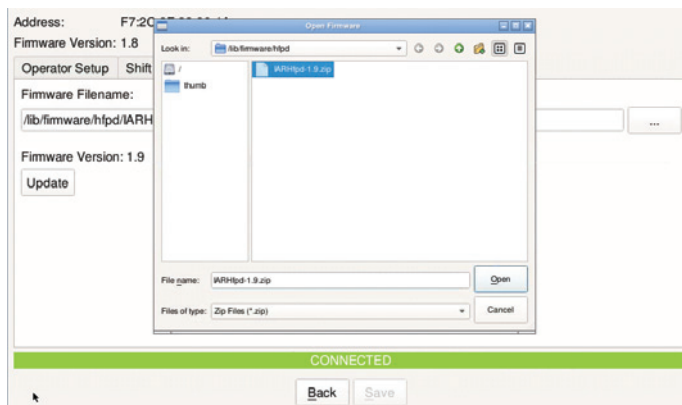

5. Navigate to the HFPD firmware feature.
6. Select the file and press “Open” to finalize the selection.
7. Close the file selection window.
8. Press “Upgrade Firmware” start the upgrade.

A message will popup stating Successful upgrade installation when upgrade is complete. The upgrade will copy a firmware file named IARHFPD-X.X.zip in the /lib/firmware/hfpd/ folder.

Now the firmware file can be upload to the HFPD using the *Hands Free Login App*.

## Uploading Firmware

### To upload firmware

1. Open the Hands Free app and edit the device you wish to upgrade.
2. Once connected to the device you will need to navigate to the “Firmware” tab.
3. Then press the “...” button to open the file selection.
4. Use the file selection to select the firmware file to be installed.

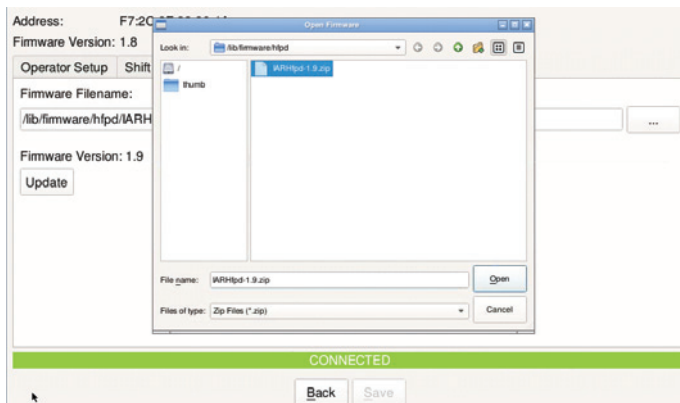

5. Press Open to finalize the selection.
6. Press “Update” to flash the firmware to the HDFPD.

A window will appear showing the progress of the upgrade and notify the user when the upgrade is complete.

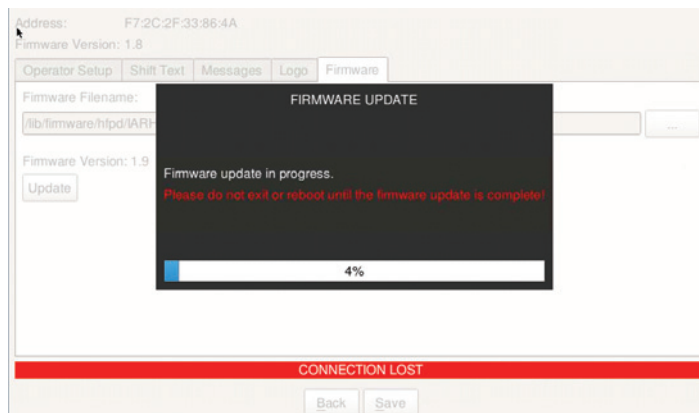

## Alerts

Hobart equipment can be configured to automatically send alerts to nearby HFPDs when the equipment encounters an error. Alerts will be sent to all devices within range of the scale. They can be configured to be sent when the issue occurs and when the issue is resolved.

**Alert Configuration**

To configure automatic alert messages on a scale

1. Navigate to the “Supervisor Pages” and press “ALL FUNCTIONS”.
2. Press “Email Alerts”.



3. Once the Email Alerts page is displayed navigate to the “Hands-Free Device Alerts”.

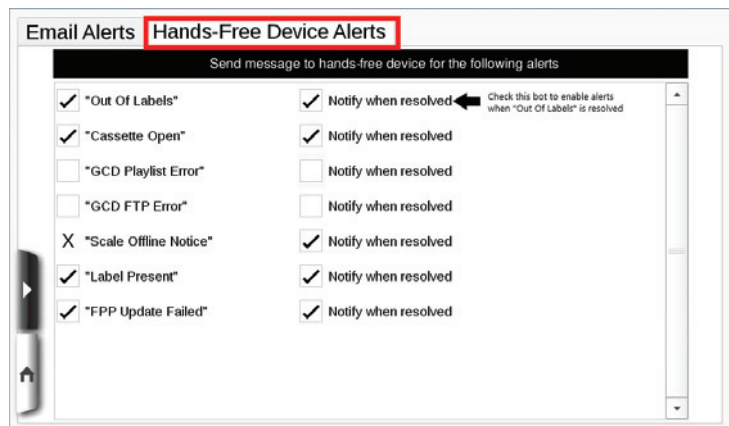

4. Check the boxes next to the desired alerts to enable the Alert for that issue.
5. Checking the “Notify when resolved” box across from the issue will send an Alert when the issue is resolved. The delay indicated on the “Email Alerts” tab applies to both email alerts and HFPD alerts.

**NOTE:** When any of the configured issues are detected or resolved, the scale will send a message to all nearby HFPD. The message will start with a “P:” or an “R:” then will state the error. “P:” is sent when the error is detected  
“R:” is sent when the issue is resolved.  
For example, when Out Of Labels is detected the scale will send “P: Out Of Labels”.

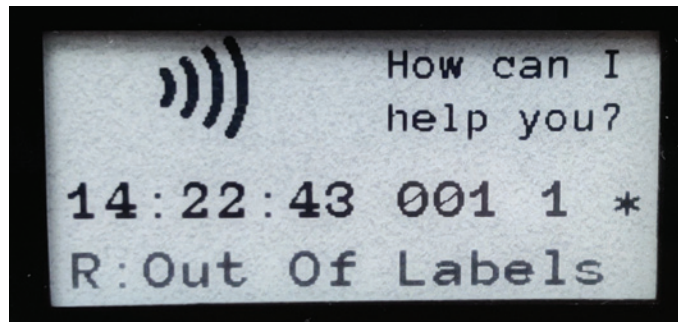
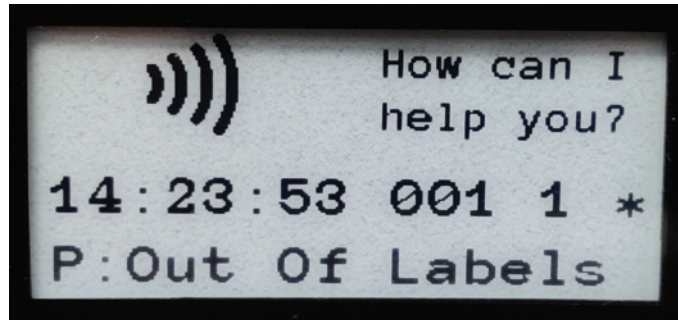



# Index

## A

Accumulate Items, 2-7  
 Adjusting Console Position, 4-8  
 Alert Configuration, 5-13  
 Alerts, 5-12

## C

Center Operator Screen, 3-4  
 Checking Printhead Dot Status, 4-11  
 Cleaning the Exterior of Scale, 4-13  
 Cleaning the Printhead, 4-12  
 Communication Connections, 2-1  
 Cutting Test, 3-41

## E

Electrical Connections, 2-1

## F

FCC Note, 1-1, 5-11  
 Firmware, 5-10  
 Fixed Features on the Operator, 2-3

## H

Hands Free Login, 5-1  
 Hands-Free Pager Device Hardware, 5-1  
 Help, 3-23  
 HFPD Display, 5-1  
 HT Scale System, 1-1  
 HTi Self-Service Scale, 3-26

## I

Installing the Auto-Cutter Label Cassette (for Linerless Labels), 4-4  
 Installing the Label Cassette, 4-1

## K

Keypad and Keyboard Icons, 2-11

## L

Leaving Self Service Mode, 3-34  
 Leveling the Scale, 4-9  
 Loading the Label Cassette, 4-3  
 Loading the Linerless Label Roll into Auto-Cutter Cassette, 4-6  
 Logging onto the System, 3-2

## M

Maintenance & Cleaning, 4-1  
 Manual Mode, 2-6  
 Menu Icon Features, 2-9  
 Modifying the Operator Screens, 3-6  
 Modifying the Printer Settings, 3-13  
 Multi Department, 3-40

## O

Operator Manual Terminology, 1-2  
 Operator Screens Overview, 2-2

## P

Power Up the System, 3-1  
 Prepack Mode, 2-7  
 Printhead Cleaning Kit, 4-12  
 Printhead Cleaning Kit Part Number, 4-12  
 Production Entry, 2-7

## R

Reboot Button, 3-1  
 Removing the Auto-Cutter Label Cassette (for Linerless Labels), 4-3  
 Removing the Label Cassette, 4-1  
 Removing the Label Roll, 4-2  
 Removing the Label Roll from Auto-Cutter Cassette (for Linerless Labels), 4-5  
 Removing the Scale Platter, 4-7  
 Replacing the Scale Platter, 4-7  
 Right Operator Screen, 3-5  
 Running a Product, 3-10

## S

Scale Operation Mode Setup, 2-6  
 Search by Description, 3-18  
 Search by PLU, 3-18  
 Select a Total Type, 3-15  
 Selecting Label Stock Type, 3-43  
 Shutting Down the System, 3-3

## T

Troubleshooting, 4-13

## U

Understanding the System, 2-1  
 Uploading Firmware, 5-12  
 Using Create COOL, 3-12  
 Using Meal Planner, 3-37, 3-38  
 Using Now Serving Tickets, 3-24  
 Using Self Service Mode, 3-27  
 Using the Flashkey Editor, 3-24  
 Using the HT System, 3-1

## V

Verify Correctness of Weight and Price, 1-2  
 Viewing Operator Note, 3-20  
 Viewing Product Notes, 3-19  
 Viewing Weights & Measures Information, 3-21  
 Void a Transaction, 3-15

